

Burner control units BCU 570

Technical Information · GB
6 Edition 05.18

- For monitoring and controlling modulating individual burners and forced draught burners of unlimited capacity
- For directly ignited burners or burners ignited by a gas pilot in intermittent or continuous operation
- Perform safety functions in accordance with EN 746-2 and EN 676
- Optionally with valve proving system
- Flexible range of applications due to parameterization possibilities
- Optional bus module for fieldbus connection



Contents

Burner control units BCU 570	1	5.1 Tightness test.....	24
Contents	2	5.1.1 Test instant	25
1 Application	5	5.1.2 Program sequence	26
1.1 Application examples	7	5.2 Test period t_p	28
1.1.1 Modulating-controlled forced draught burner.....	7	5.2.1 Extended opening time t_L	29
1.1.2 Modulating-controlled forced draught burner with valve proving system	8	5.2.2 Measurement time t_M	31
1.1.3 Modulating-controlled forced draught burner with gas pilot and valve proving system.....	9	5.3 Proof of closure function	34
1.1.4 Limitation of the ignition rate in accordance with SIL/PL.....	10	5.3.1 Program sequence	34
1.1.5 Controlling the BCU via Profinet	12	6 BCSOft	35
1.1.6 Controlling the BCU and the butterfly valve via Profinet.....	12	7 Fieldbus communication via Ethernet	36
2 Certification	13	7.1 BCU and bus module BCM.....	37
3 Function	14	7.2 Configuration, planning	38
3.1 Part designations	14	7.2.1 Profinet/Device master data file (GSD)	38
3.2 Connection diagram	15	7.2.2 Modbus TCP	38
3.2.1 BCU 570 with ionization control in double- electrode operation	15	7.2.3 Modules/Registers for process data	39
3.2.2 With ionization control in single-electrode operation	16	7.2.4 Device parameters and statistics.....	44
3.2.3 With parallel ionization control of pilot/main burner.....	16	8 Program step/status	45
3.2.4 With parallel ionization control of pilot and UV control of main burner.....	16	9 Fault signalling	46
3.2.5 With UVS control	16	10 Parameter	49
3.2.6 With UVC control	16	10.1 Scanning the parameters.....	53
3.2.7 Assignment of connection terminals	17	10.2 Flame control.....	53
3.3 Program sequence.....	19	10.2.1 Burner 1 FS1 flame signal switch-off threshold... 53	
3.3.1 Normal start-up	19	10.2.2 Flame control	53
4 Air control	21	10.3 Behaviour during start-up	54
4.1 Controlled air flow	22	10.3.1 Burner 1 start-up attempts	54
4.2 Capacity control	23	10.3.2 Start-up with pre-purge after controlled shut- down within 24 hours	55
5 Valve proving system	24	10.3.3 Burner application	56
		10.3.4 Pre-ignition time t_{VZ}	58
		10.3.5 Safety time 1 t_{SA1}	58
		10.3.6 Flame proving period 1 t_{FS1}	59
		10.3.7 Safety time 2 t_{SA2}	59
		10.3.8 Flame proving period 2 t_{FS2}	60
		10.4 Behaviour during operation	61
		10.4.1 Restart.....	61

10.4.2 Minimum operating time t_B	63	11 Selection	93
10.4.3 Pilot burner.....	63	11.1 Type code	93
10.5 Safety limits	64	12 Project planning information.....	94
10.5.1 Emergency stop.....	64	12.1 Installation.....	94
10.5.2 High gas pressure protection	64	12.2 Commissioning.....	94
10.5.3 Low gas pressure protection.....	65	12.3 Electrical connection.....	95
10.5.4 Low air pressure protection.....	65	12.3.1 OCU	95
10.5.5 Safety time during operation t_{SB}	66	12.3.2 Safety current inputs.....	96
10.6 Air control.....	66	12.4 Actuators	97
10.6.1 Fan run-up time t_{GV}	66	12.4.1 IC 20.....	97
10.6.2 Air monitoring during controlled air flow.....	66	12.5 Air control.....	97
10.6.3 Pre-purge time t_{PV}	67	12.6 Parameter chip card	97
10.6.4 Air flow monitoring during pre-purge	67	13 Accessories.....	98
10.6.5 Post-purge time t_{PN}	68	13.1 BCSoft	98
10.6.6 Air flow monitoring during post-purge.....	69	13.1.1 Opto-adaptor PCO 200	98
10.6.7 Capacity control.....	69	13.1.2 Bluetooth adapter PCO 300	98
10.6.8 Running time selection	77	13.2 OCU.....	98
10.6.9 Running time.....	78	13.3 Connection plug set.....	99
10.6.10 Low fire over-run.....	78	13.4 Stickers for labelling	99
10.6.11 Controller enable signal delay time t_{RF}	79	13.5 "Changed parameters" stickers.....	99
10.6.12 Capacity control (bus).....	79	14 OCU	100
10.7 Valve check	86	14.1 Application.....	100
10.7.1 Valve proving system	86	14.2 Function	101
10.7.2 Relief valve (VPS).....	86	14.2.1 Manual mode.....	101
10.7.3 Measurement time V_{p1}	87	14.3 Electrical connection	102
10.7.4 Valve opening time t_{L1}	87	14.4 Installation.....	102
10.8 Behaviour during start-up	88	14.5 Selection.....	102
10.8.1 Minimum pause time t_{MP}	88	14.6 Technical data	103
10.8.2 Switch-on delay time t_E	88	15 BCM.....	104
10.9 Manual mode	89	15.1 Application.....	104
10.9.1 Operating time in Manual mode	90	15.2 Function	104
10.10 Functions of terminals 51, 65, 66, 67 and 68. 90	90	15.3 Electrical connection.....	104
10.10.1 Function of terminal 51.....	90	15.4 Installation.....	104
10.10.2 Function of terminal 65.....	91	15.5 Selection.....	105
10.10.3 Function of terminal 66.....	91		
10.10.4 Function of terminal 67.....	91		
10.10.5 Function of terminal 68.....	91		
10.11 Password	92		
10.12 Fieldbus communication	92		

15.6 Technical data	105
16 Technical data	106
16.1 Electrical data	106
16.2 Mechanical data	107
16.3 Environment	107
16.4 Dimensions	107
16.5 Safety-specific characteristic values	108
16.6 Converting units	109
17 Maintenance	110
18 Legend	111
19 Glossary	112
19.1 Waiting time t_W	112
19.2 Ignition time t_Z	112
19.3 Safety interlocks	112
19.4 Safety time on start-up t_{SA1}	112
19.5 Safety time during operation t_{SB}	112
19.6 Safety shut-down	113
19.7 Fault lock-out	113
19.8 Warning signal	114
19.9 Timeout	114
19.10 Lifting	114
19.11 Air valve	114
19.12 Diagnostic coverage DC	114
19.13 Mode of operation	115
19.14 Safe failure fraction SFF	115
19.15 Probability of dangerous failure PFH_D	115
19.16 Mean time to dangerous failure $MTTF_d$	115
Feedback	116
Contact	116

1 Application



BCU 570 with plug-in spring-force connection terminals

Burner control unit BCU 570 controls, ignites and monitors industrial individual burners and forced draught burners of unlimited capacity in intermittent or continuous operation. It can be used for directly ignited burners or burners ignited by a gas pilot.

The BCU 570 has an interface for control elements for burner capacity control. Both actuators (IC 20, IC 40, 3-point step and RBW) and frequency converters can be controlled. A valve proving system can be integrated as an option.

The BCU 570 activates the fan and sets a connected actuator or frequency converter to pre-purge and ignition positions.

If the centrally checked safety requirements, e.g. pre-purge, flow detector and pressure switch check, have been met, the BCU 570 starts the burner. An enable signal is then issued to an external temperature controller which controls the actuator or frequency converter in accordance with the capacity demand.

The burner control unit BCU 570 monitors the gas and air pressure. The optionally integrated valve proving system checks the valves by checking an external gas pressure switch or by checking whether the gas valve on the inlet side is closed.

Using the BCSoft program, the parameters, analysis and diagnostic information can be read from the BCU via the optionally available opto-adaptor. All valid parameters are saved on the integrated parameter chip card. The parameter chip card can be removed easily, for example when the unit is replaced, and inserted into a new BCU to transfer the parameters.

An integrated Manual mode allows the manual activation of the burner control units and adjustment of the butterfly valves.

Application

The fan output and the actuator and valve outputs which are checked for faults are accommodated in a plug-in power module. This can simply be replaced if necessary.



Once the plug-in power module has been removed, the parameter chip card and fuses are accessible.

The BCU can be installed on a DIN rail in the control cabinet. The plug-in connection terminal strips make it easier to install and remove.

The external operator-control unit OCU is available as an option for the BCU. The OCU can be installed in the control cabinet door instead of standard control units. The program step/status or fault messages can be read on the OCU. For burner adjustment, the operating points can be approached conveniently in Manual mode using the operator-control unit.



Thanks to the operator-control unit OCU, display functions and operation of the BCU can be relocated to the control cabinet door.

Using the bus module BCM 500, the BCU can be networked with a fieldbus system. Networking in a fieldbus system enables the burner control unit BCU 570 to be controlled and monitored by an automation system (e.g. PLC). This also opens up a wide range of process visualization possibilities.

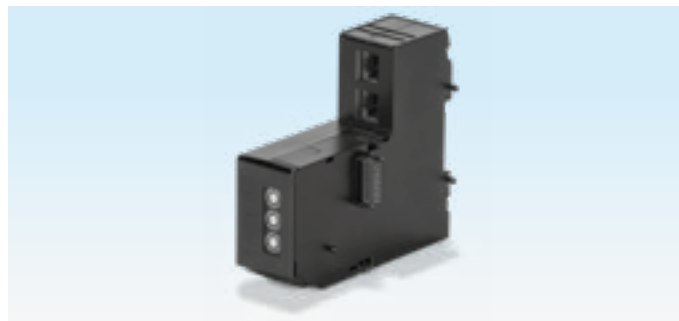

Bus module BCM 500 for DIN rail installation for lateral connection to the BCU

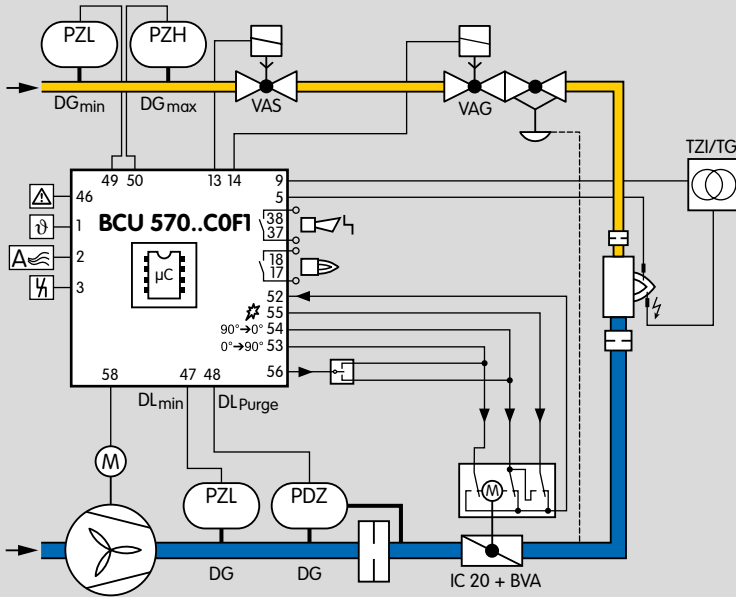

1.1 Application examples

1.1.1 Modulating-controlled forced draught burner

The BCU 570 controls the fan, monitors the combustion media air and gas, controls pre-purge and moves the butterfly valve to pre-purge and ignition positions. Once the BCU 570 has started the burner, it issues the enable signal to the external temperature controller which then assumes the control task.

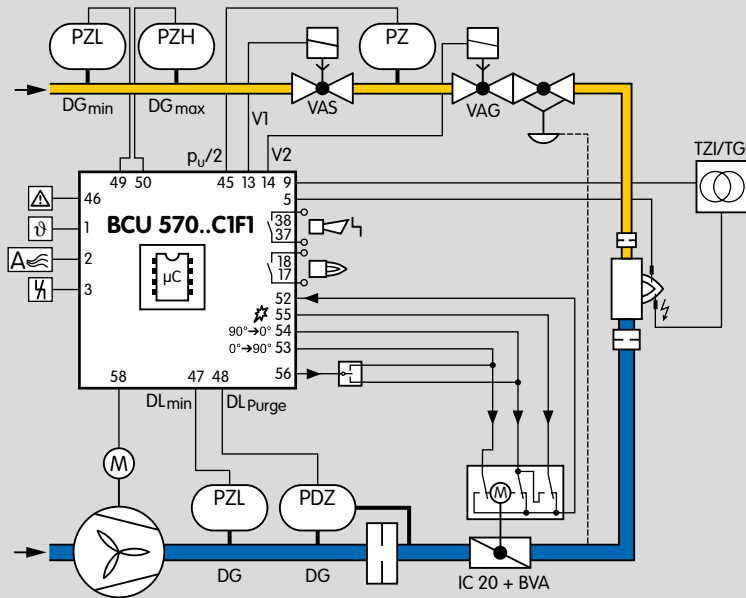

1.1.2 Modulating-controlled forced draught burner with valve proving system

The BCU 570..C1 is fitted with an integrated valve proving system. This allows the tightness of two gas solenoid valves and the pipework to be checked. Optionally, the closed position of a gas solenoid valve can also be checked using a POC switch.

The tightness control function satisfies the requirements of EN 1643 (Valve proving systems for automatic shut-off valves for gas burners and gas appliances).

By checking the closed position using the proof of closure function, the BCU complies with the requirements of NFPA 85 (Boiler and Combustion Systems Hazards Code) and NFPA 86 (Standard for Ovens and Furnaces).

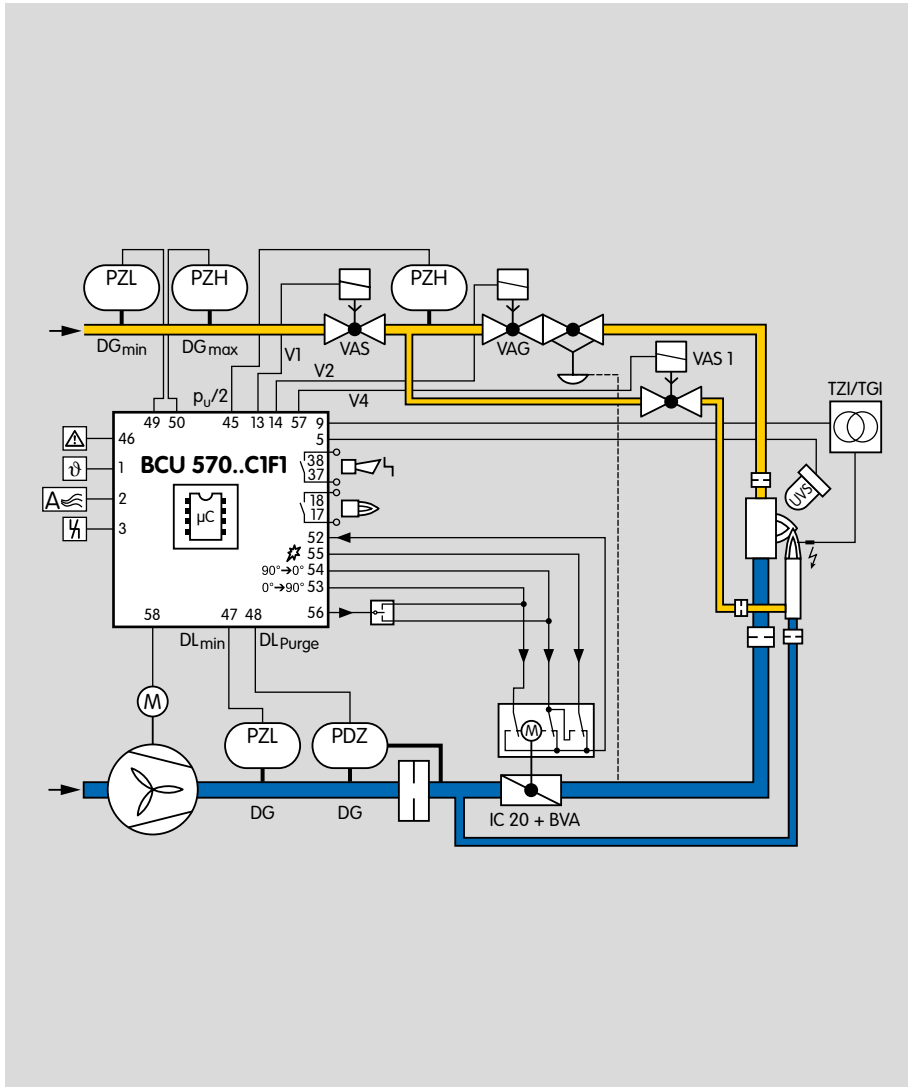

1.1.3 Modulating-controlled forced draught burner with gas pilot and valve proving system

The burner is ignited by a gas pilot. The integrated valve proving system checks the tightness of all gas valves and the pipework between the gas solenoid valves with the aid of the pressure switch.

Parameters may be used to decide whether the gas pilot should be operated permanently or is switched off during the main burner's safety time.

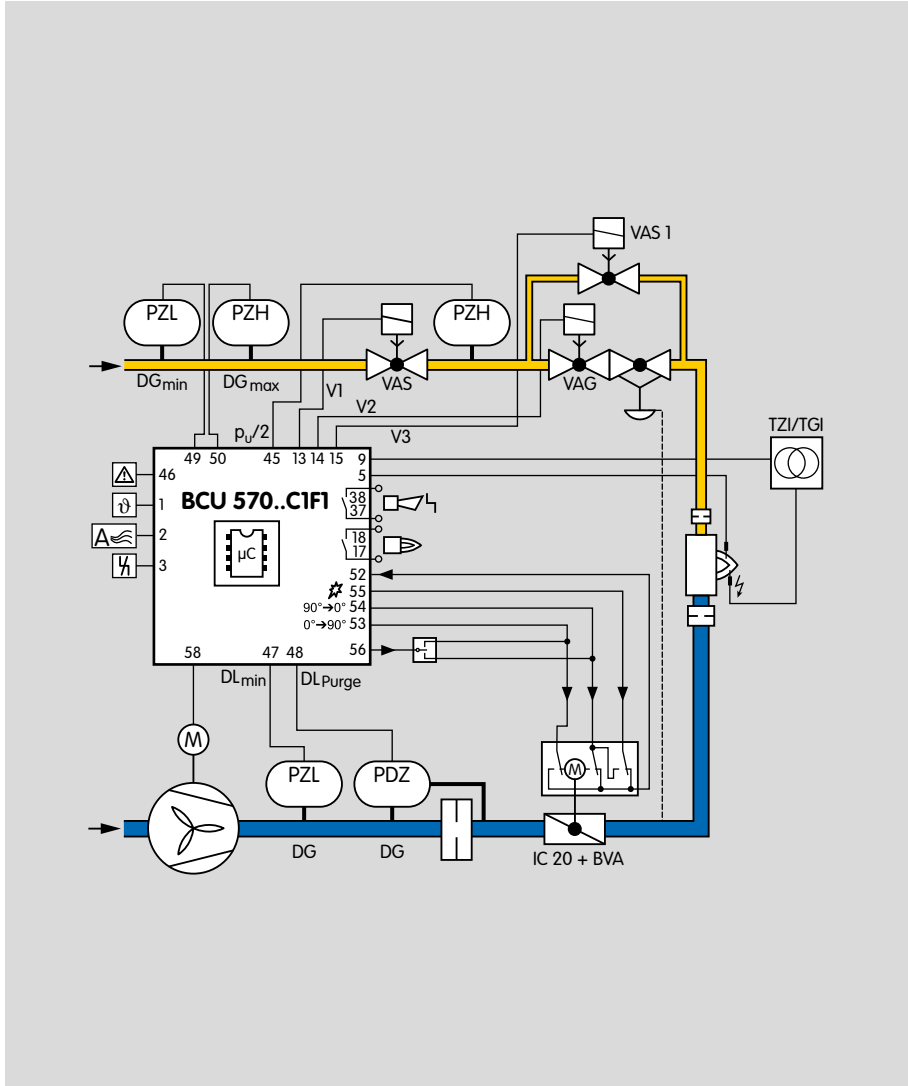

1.1.4 Limitation of the ignition rate in accordance with SIL/PL

The burner can be started with a defined ignition rate using the connected gas valve V3. Once the BCU has been informed that the burner is in operation, gas valve V2 opens. Gas valve V3 closes.

It is thus possible to limit the ignition rate in accordance with the valid SIL/PL safety requirements.

The safe limitation of the ignition rate can be used for both applications with a single burner and burners with gas pilots.

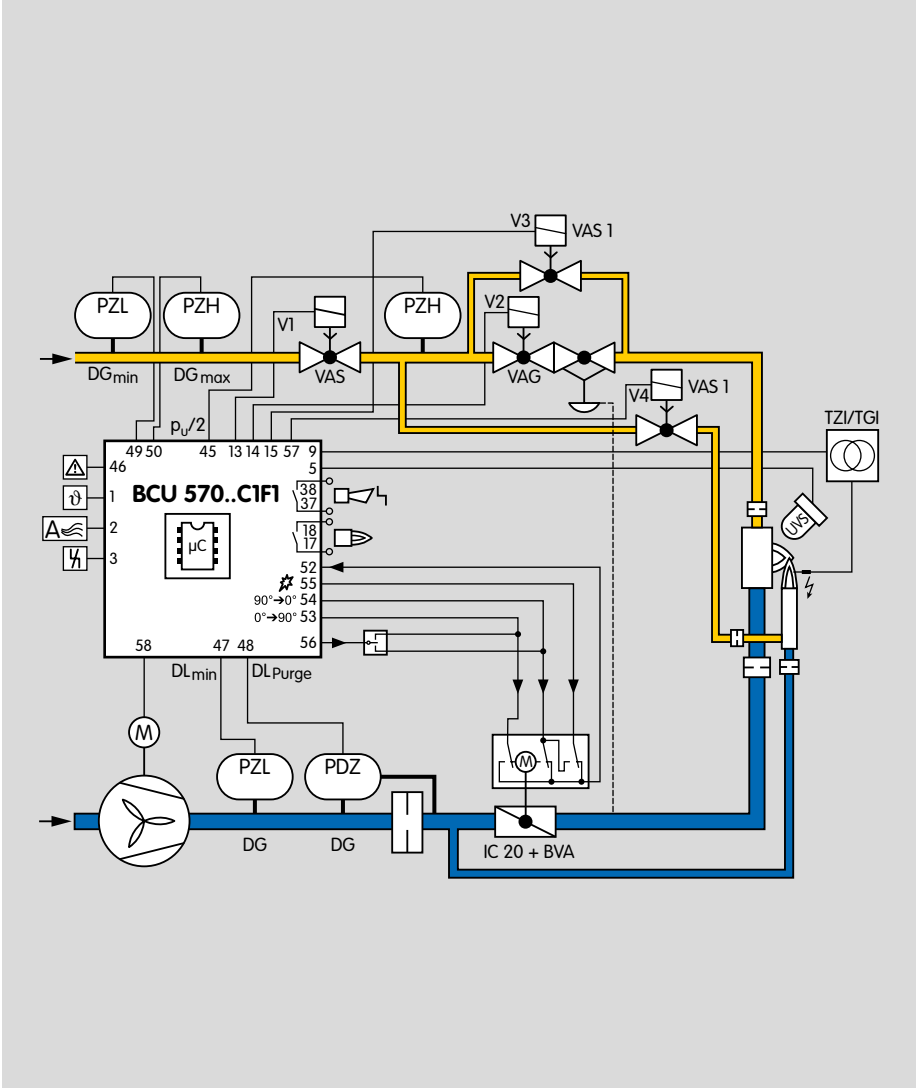

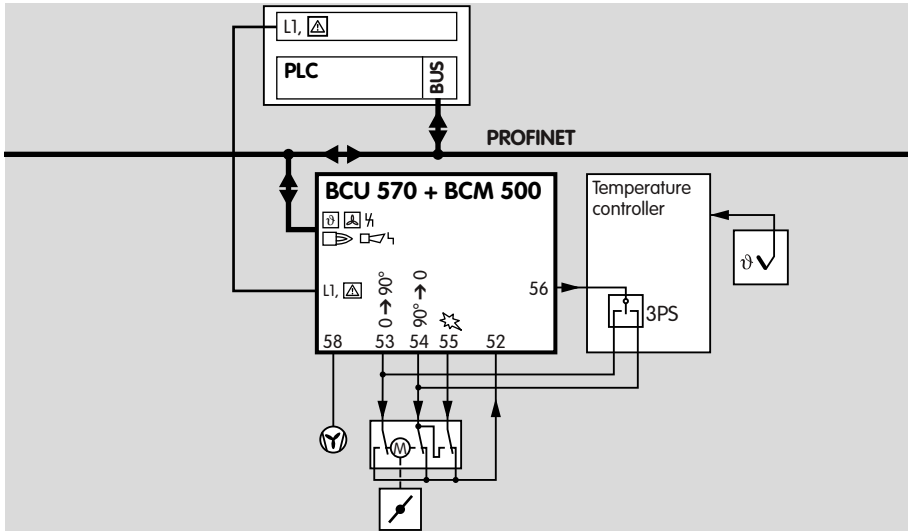

1.1.5 Controlling the BCU via Profinet

The BCU issues the enable signal to the temperature controller for capacity control. The temperature controller then controls the butterfly valve directly.

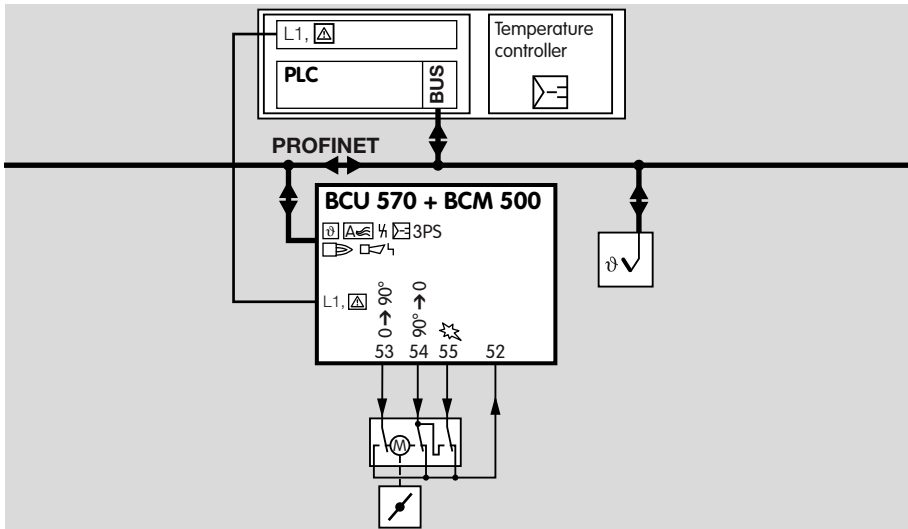

1.1.6 Controlling the BCU and the butterfly valve via Profinet

The BCU receives positioning information for the butterfly valve from the temperature controller via Profinet and activates the butterfly valve following controller enable.

2 Certification

Certificates – see Docuthek.

Certified to SIL and PL



For systems up to SIL 3 pursuant to EN 61508. Pursuant to EN ISO 13849-1, Table 4, the BCU can be used up to PL e.

EU certified pursuant to



Directive:

- Low Voltage Directive (2014/35/EU)
- EMC Directive (2014/30/EU)

Regulation:

- Gas Appliances Regulation (EU) 2016/426

ANSI/CSA approved



American National Standards Institute/Canadian Standards Association – ANSI Z21.20/CSA C22.2, No. 199/UL 372, www.csagroup.org – Class number: 3335-01 (natural gas, LPG), 3335-81 (natural gas, propane).

FM approved



Factory Mutual Research Class: 7610 Combustion Safeguards and Flame Sensing Systems. Designed for applications pursuant to NFPA 85 and NFPA 86.

www.approvalguide.com

UR recognized



Underwriters Laboratories – UL 372 “Standard for Limit Controls”.

www.ul.com → Tools (at the bottom of the page) → On-line Certifications Directory

AGA approved



Australian Gas Association, Approval No.: 8321

http://www.aga.asn.au/product_directory

Eurasian Customs Union



The product BCU 570 meets the technical specifications of the Eurasian Customs Union.

3 Function

3.1 Part designations

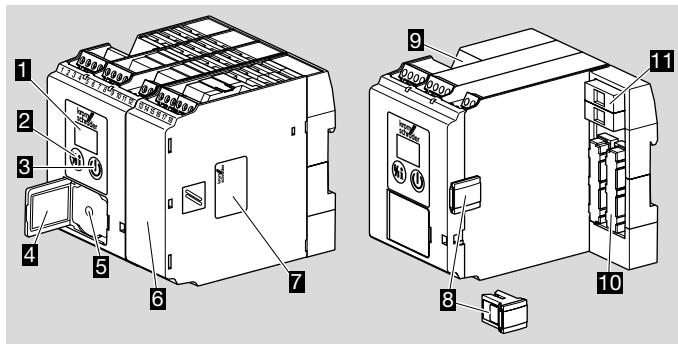

1	LED display for program status and fault messages To display the program status or fault message and, in conjunction with the Reset/Information button, to display the flame signal and the fault history or to view and set device parameters.
2	Reset/Information button To reset the control unit to its starting position in the event of a fault. System faults (internal errors) can only be acknowledged using this button.
3	On/Off button To switch the control unit on or off
4	BCU type label Visible when the hinged cover is open
5	Connection for opto-adaptor
6	Power module, replaceable
7	Power module type label
8	Parameter chip card (PCC), replaceable
9	OCU connection terminals
10	Contact strip for power module
11	Device fuses, replaceable

There are two control keys for the control unit:

	ON/OFF Use the ON/OFF key to switch the control unit on or off.
	Reset/Information The control unit is reset to its starting position in the event of a fault using the Reset/Information button.

During operation, the LED display shows the program status. The flame signal intensity, the fault history and the parameters can be called up on the display by repeatedly pressing the Reset/Information button (for 1 s). The parameter display is ended 60 seconds after the last time the button is pressed or by switching off the BCU. When the BCU is switched off, is displayed. The parameters cannot be scanned when the BCU is switched off or when a fault/warning is displayed.

Display	Information
<i>F1</i>	Burner 1 flame signal intensity
<i>E0</i> to <i>E9</i>	Last fault message to tenth to last fault message
<i>01</i> to <i>99</i>	Parameter 01 to parameter 99

3.2 Connection diagram

3.2.1 BCU 570 with ionization control in double-electrode operation

Connection diagrams for actuators and frequency converters, see from page 23 (Capacity control)

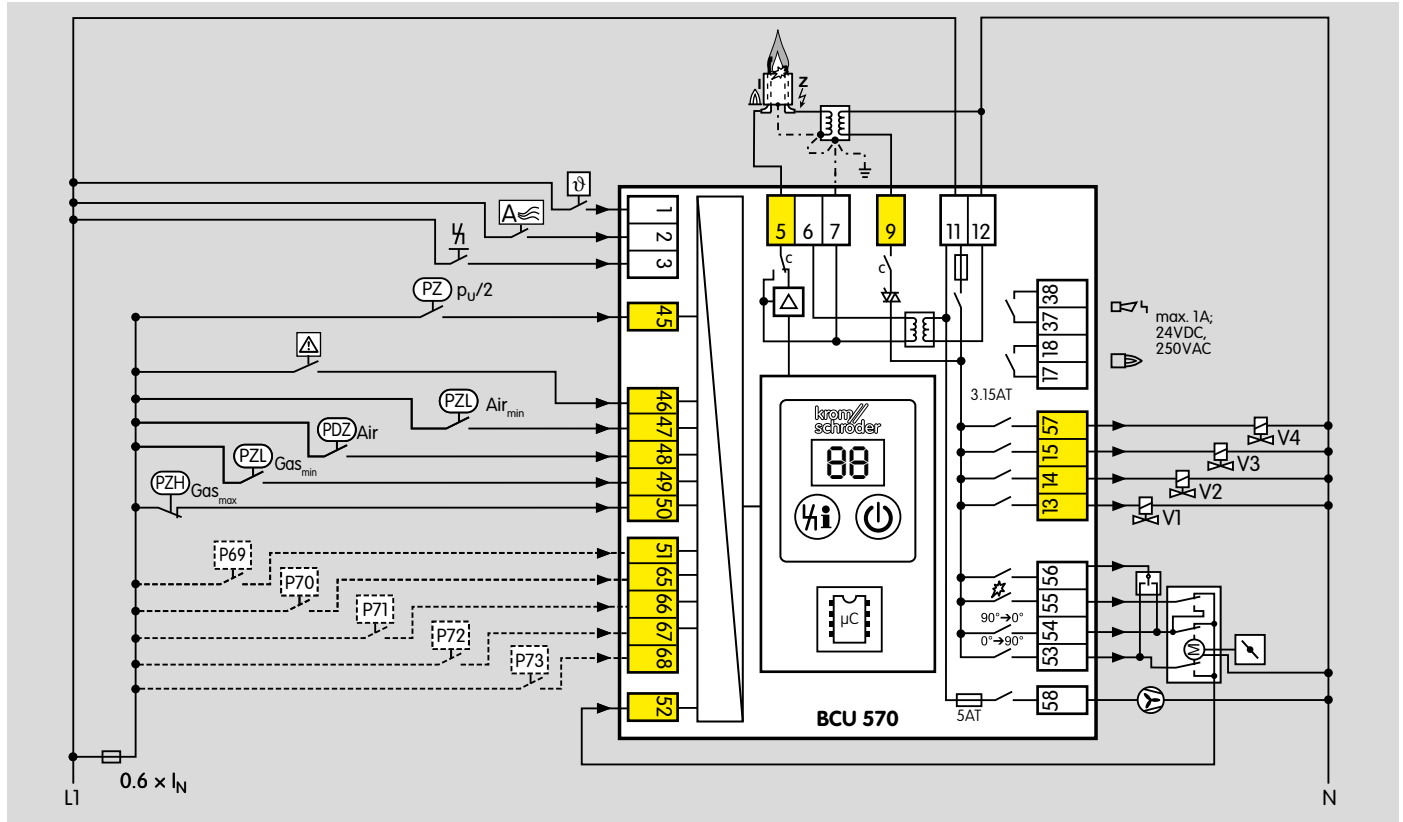

Electrical connection, see page 94 (Project planning information)

Explanation of symbols, see page 111 (Legend)

3.2.2 With ionization control in single-electrode operation

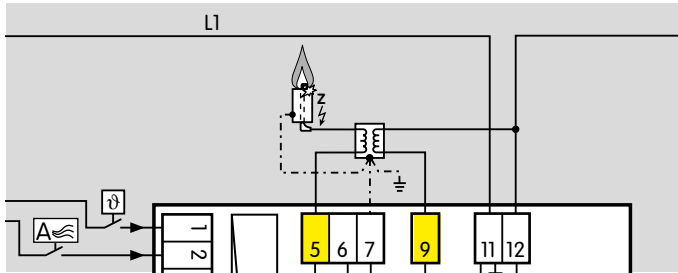

3.2.3 With parallel ionization control of pilot/main burner

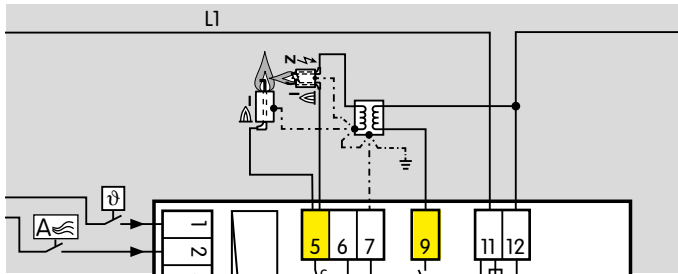

Two flame rods can be connected in parallel to the ionization input. This is necessary, for example, if a pilot/main burner combination needs to be monitored where both the pilot and the main burner are fitted with a flame rod.

3.2.4 With parallel ionization control of pilot and UV control of main burner

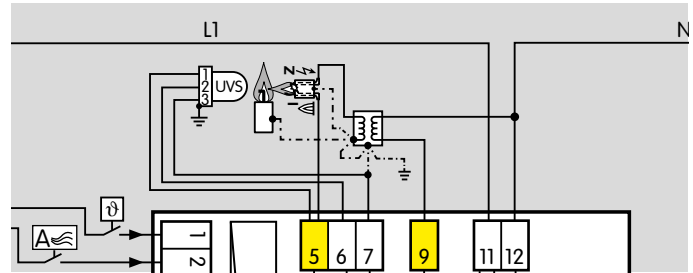

3.2.5 With UVS control

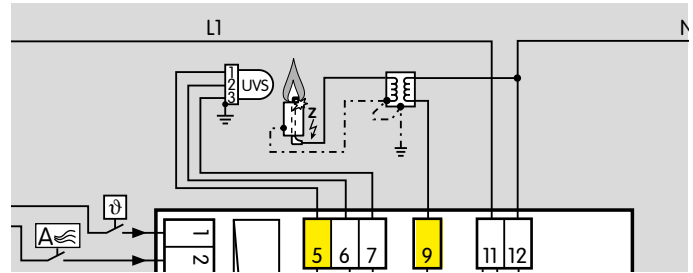

3.2.6 With UVC control

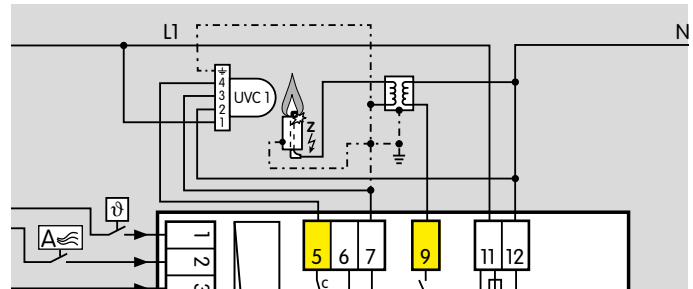

3.2.7 Assignment of connection terminals

Terminal	Type	Designation	Function
1	Control input (AC mains voltage)	Start-up signal	Signal applied: heating start; no signal: heating stop
2		Controlled air flow	Signal applied: fan is started to supply air to the combustion chamber for cooling, for example. Controlled air flow is only possible in standby with deactivated start-up signal. As soon as heating operation is started (start-up signal at terminal 1), the function is interrupted.
3		Remote reset	Input for external signal (button) to reset the unit after a fault lock-out. System faults (internal errors) can only be acknowledged using this button.
5	Input (μ A)	Flame signal	Connection for flame rod/UV sensor/ignition transformer
6	Output	UV sensor	Supply voltage for UV sensor UVS
7	Ground	Burner ground	Connection to be connected to the electrically conductive structure of a burner/furnace
9	Output (AC mains voltage)	Ignition	Connection for an ignition transformer or ignition unit
11, 12	Supply (AC mains voltage)	Supply voltage	Mains supply, 11 = phase (L1), 12 = neutral conductor (N)
13	Valve outputs (AC mains voltage)	Gas valve V1	Connection for gas valve V1
14		Gas valve V2	Connection for gas valve V2
15		Gas valve V3	Connection for gas valve V3
57		Gas valve V4	Connection for gas valve V4



Function

Terminal	Type	Designation	Function
17	Floating contact	Operating signal	Contact between terminals 17 and 18 closes once the operating signal has been received from the burner
18			
37		Fault signal	Contact between terminals 37 and 38 closes in the event of a BCU fault lock-out
38			
45	Safety circuit input (AC mains voltage)	Valve proving system	Connection for the sensor of the valve proving system (tightness control pressure switch or POC switch for checking the closed position)
46		Controller enable/emergency stop	Connection for higher-level safety devices and interlocks (e.g. emergency stop), see Parameter 10
47		Minimum air pressure	Connection for pressure switch to monitor the minimum air pressure, see Parameter 15
48		Minimum air flow	Connection for a sensor to monitor the minimum air flow during pre-purge or post-purge, see Parameter 35, 38
49		Minimum gas pressure	Connection for pressure switch to monitor the minimum gas pressure, see Parameter 13
50		Maximum gas pressure	Connection for pressure switch to monitor the maximum gas pressure, see Parameter 12
51, 65, 66, 67, 68		Programmable fail-safe inputs	The terminals can be assigned a function using parameters. To do so, logical AND gatings with terminals 46, 47, 48, 49 or 50 are possible, for example.
52	Feedback from actuator/frequency converter	Feedback input for minimum and maximum capacity	
53, 54, 55, 56	Outputs (AC mains voltage)	Capacity control	Connection for capacity control using an actuator or frequency converter, see Parameter 40 to 47
58		Fan	Connection for fan control. If the fan is not controlled by the BCU, this output can be used as an alternative to control a valve for the air pressure switch function check.

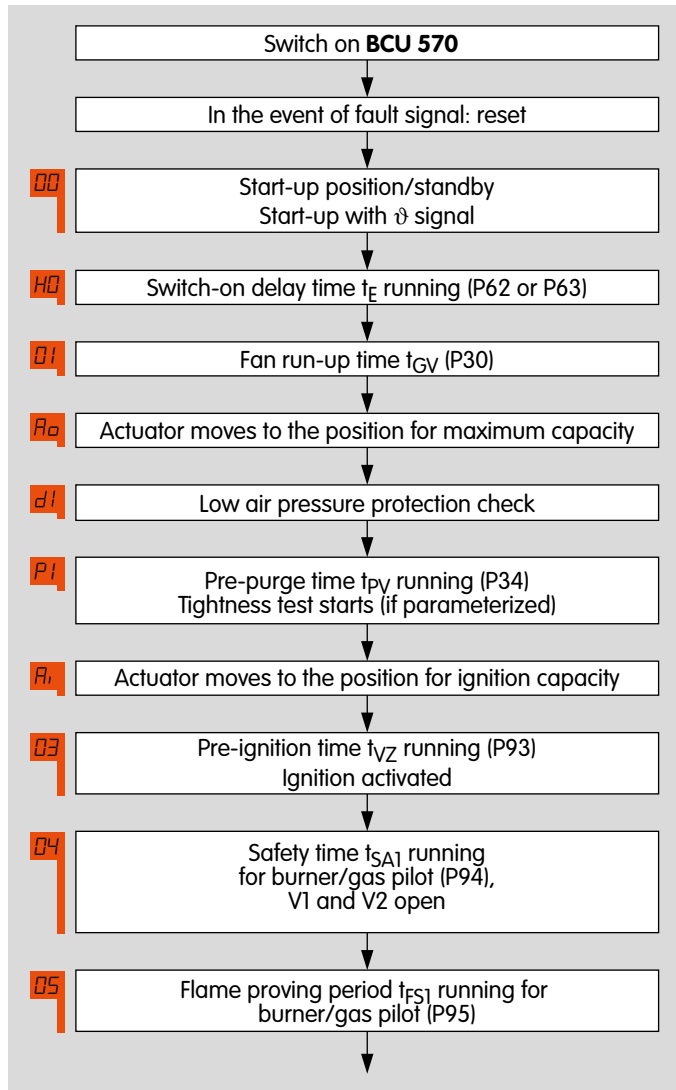

3.3 Program sequence

3.3.1 Normal start-up

If a fault from the preceding operating cycle is still being signalled after switching on, it will be necessary to reset this first. The BCU 570..C1 has an integrated valve proving system which starts the tightness test or proof of closure function after the BCU has been switched on.

Once the start-up signal (ϑ) has been applied, the switch-on delay t_E starts to elapse (display HD).

During the fan run-up time t_{GV} (display 01) which follows, the fan starts with the butterfly valve being closed. Afterwards, the actuator moves from the position for minimum capacity to the position for maximum capacity. The air pressure is checked using the differential pressure switch (display d1). The pre-purge time t_{PV} (display P1) starts if the air flow is sufficient.

After the pre-purge time has elapsed and the valve check has been successfully completed (if parameterized on the BCU 570..C1), the actuator moves to the position for ignition capacity (display Ri). The running times depend on the connected actuator. The BCU waits for actuator feedback before continuing the program sequence.

Now the BCU starts the pre-ignition time t_{VZ} (display 03) and then opens valves V1 and V2 for the gas pilot (display 04). The ignition time t_Z starts. After the first flame proving period t_{FS1} (for the gas pilot, display 05), the BCU opens valve V3 to start the burner (main burner).

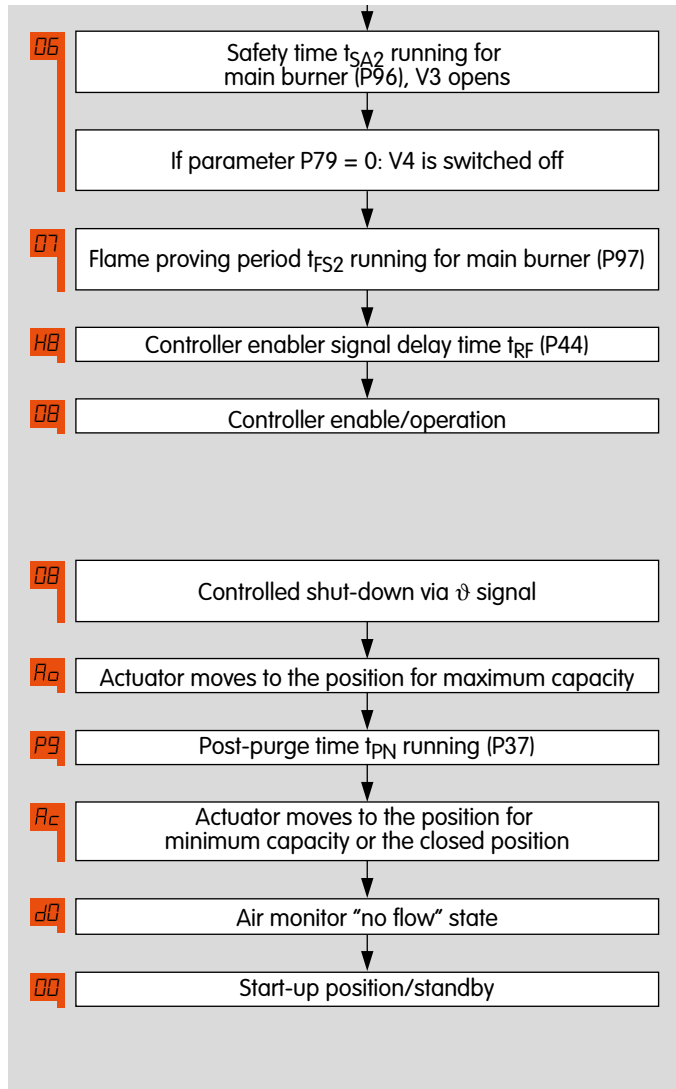

If parameter 79 = 0, V4 closes shortly before the second safety time t_{SA2} for the main burner has elapsed (display 05). The gas pilot is switched off.

This is followed by the flame proving period t_{FS2} for the main burner (display 07) and the controller enable signal delay time t_{RF} . The BCU then issues the controller enable signal for the actuator (display 08). The BCU is in operation.

If there is no gas pilot, program steps 05 and 07 will be omitted.

As soon as the start-up signal (ϑ) is switched off, the post-purge time starts to elapse (display P9). During this, the butterfly valve moves to the position for ignition capacity and then to the position for minimum capacity or the closed position (display Rc). Next, the BCU rests in the start-up position/standby (display 00).

4 Air control

The BCU 570 takes over the air control as it is the central protective system. It controls and monitors the required air volume for start-up and after the burner has been shut down. The capacity control is enabled while the burner is in operation.

The BCU 570 activates the fan. The static air pressure and the air volume for pre-purge are monitored.

3-point step actuators (for example IC 20, IC 20..E) or IC 40 actuators can be controlled and monitored via the interfaces on the BCU 570..F1. RBW actuators or frequency-controlled fans can be controlled and monitored via the interfaces on the BCU..F2. The actuator or fan is controlled by an external temperature controller.

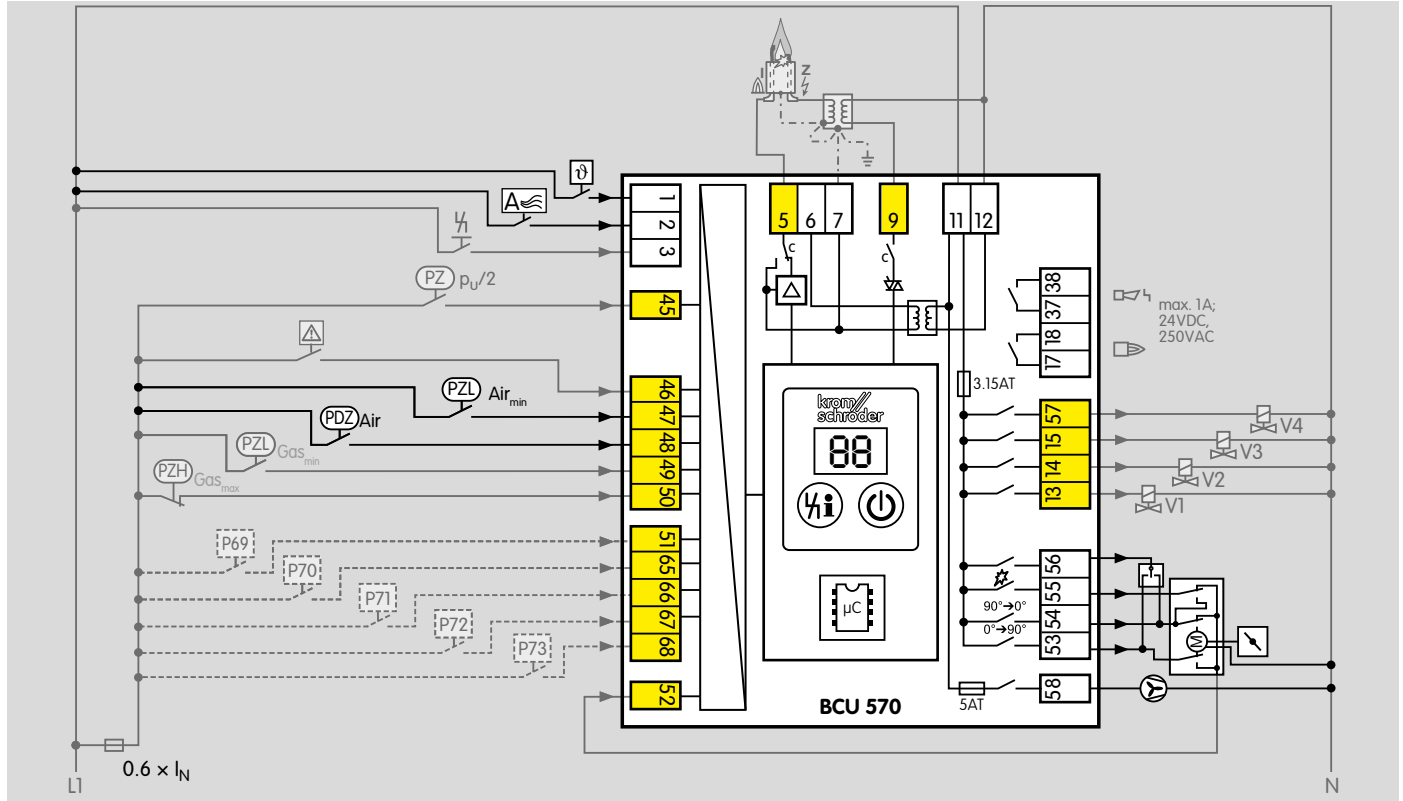

4.1 Controlled air flow

If the external air valve control input (terminal 2) is actuated in standby (without a start-up signal), the BCU will start the fan to provide air to cool the combustion chamber, for example.

The fan is started depending on the functions defined using parameters,

see also page 65 (Low air pressure protection), page 88 (Switch-on delay time t_E), page 66 (Fan run-up time t_{GV}) and page 66 (Air monitoring during controlled air flow).

As soon as a start-up signal ϑ is received at terminal 1, the controlled air flow function is stopped and a burner start is initiated.

4.2 Capacity control

The BCU 570 activates a control element via the outputs for capacity control (terminals 53 to 56) for controlled air flow, pre- and post-purge or to start the burner. This control element (butterfly valve or frequency converter) is used to set the air volume required for the relevant operating situation.

As soon as a start-up signal is received by the BCU 570 (terminal 1), the fan is started after the switch-on delay time has elapsed. The air volume for pre-purge is set using the control element via the outputs for capacity control (terminals 53 to 56). If the fan is switched on, the minimum air pressure is ensured using an air pressure switch connected to terminal 47. The pre-purge time starts if there is adequate air flow.

After the elapse of the pre-purge time, the air volume for ignition is set using the control element. If the air volume has been set and the valve check (BCU 570..C1) completed, the burner will be ignited. After the operating signal has been received from the burner and after expiry of the delay time for the controller enable signal (P44), the BCU issues the controller enable signal. Access to the control element is thus transferred to an external temperature controller. The temperature controller controls the burner capacity (air volume) on the basis of the required temperature.

Depending on the wiring for the output signals of the temperature controller (3-point step), the actuator may be adjusted between maximum capacity and ignition capacity or minimum capacity.

Depending on parameter 40, actuators IC 20 and IC 40, an actuator with an RBW interface or a fan controlled by a frequency converter can be actuated via the outputs for capacity control. For more detailed information about capacity control with actuators IC 20 and IC 40, RBW interface or frequency converter, see from page 69 (Capacity control).

As soon as the start-up signal (ϑ) is switched off, the post-purge time starts to elapse. Depending on the parameter setting, the butterfly valve moves to the position for ignition capacity and then to the position for minimum capacity or the closed position. Next, the BCU rests in the start-up position/standby.

5 Valve proving system

The BCU 570..C1 is fitted with an integrated valve proving system. This tests the tightness of the gas solenoid valves including the pipework between these valves, see page 24 (Tightness test).

Alternatively, the valve proving system may be parameterized so that a proof of closure switch checks the closed position of a gas solenoid valve, see page 34 (Proof of closure function).

Once the test has been carried out successfully, the burner enable signal is issued.

The valve proving system function satisfies the requirements of EN 1643 (Valve proving systems for automatic shut-off valves for gas burners and gas appliances).

By checking the closed position using the proof of closure function, the BCU complies with the requirements of NFPA 85 (Boiler and Combustion Systems Hazards Code) and NFPA 86 (Standard for Ovens and Furnaces).

5.1 Tightness test

The aim of the tightness control is to identify an inadmissible leak on one of the gas solenoid valves and to prevent burner start. European standards EN 746-2 and EN 676 stipulate tightness controls for capacities over 1200 kW (NFPA 86: from 117 kW or 400,000 Btu/h).

Gas solenoid valves V1 and V2 are tested as is the pipework between the valves.

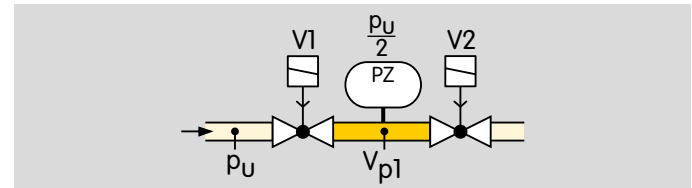

5.1.1 Test instant

Depending on the parameter setting, the tightness control checks the tightness of the pipework and the gas solenoid valves before each start-up and/or after each shut-down of the burner, see page 86 (Valve proving system).

The gas line is always safeguarded by a gas solenoid valve during this check.

Before burner start-up

The valve check is started when the start-up signal ϑ is present at terminal 1. The BCU checks the tightness of the gas solenoid valves and the pipework between the valves. The gas line is always safeguarded by a gas solenoid valve during this check. The burner is ignited when pre-purge is ended and the tightness has been checked successfully.

After burner shut-down

After the burner has been shut down, the BCU checks the tightness of the gas solenoid valves and the pipework between them. Once the test has been carried out successfully, the next burner start is enabled. The BCU immediately conducts a tightness test if mains voltage is available or if it is reset after a fault lock-out.

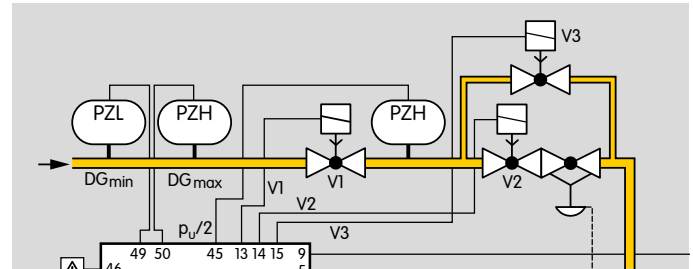

An additional bypass/relief valve must be installed in gas sections with an air/gas ratio control. This ensures that a closed air/gas ratio control is bypassed during the tightness test.

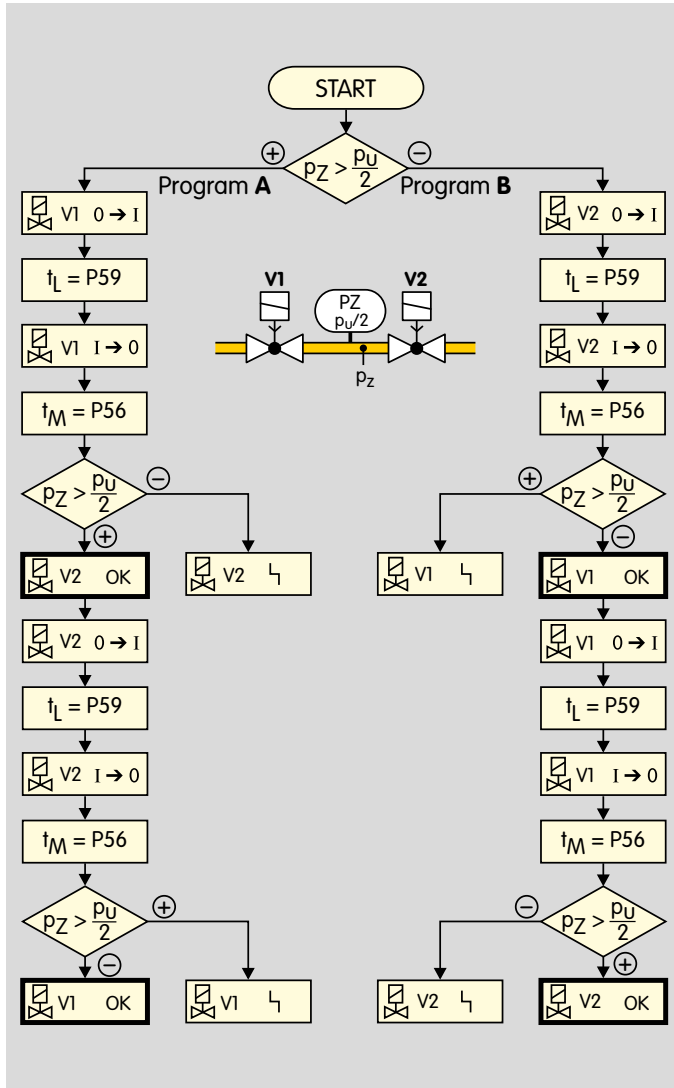

5.1.2 Program sequence

The tightness test starts by checking the external pressure switch. If pressure $p_z > p_u/2$, program A starts.

If pressure $p_z < p_u/2$, program B starts, see page 27 (Program B).

Program A

Valve V1 opens for the opening time t_L set in parameter 59. V1 closes again. During the measurement time t_M , the tightness control checks the pressure p_z between the valves.

If pressure p_z is less than half the inlet pressure $p_u/2$, valve V2 is leaking.

If pressure p_z is greater than half the inlet pressure $p_u/2$, valve V2 is tight. Valve V2 is opened for the set opening time t_L . V2 closes again.

During the measurement time t_M , the tightness control checks the pressure p_z between the valves.

If pressure p_z is greater than half the inlet pressure $p_u/2$, valve V1 is leaking.

If pressure p_z is less than half the inlet pressure $p_u/2$, valve V1 is tight.

The tightness test can only be performed if pressure p_d downstream of V2 is around atmospheric pressure.

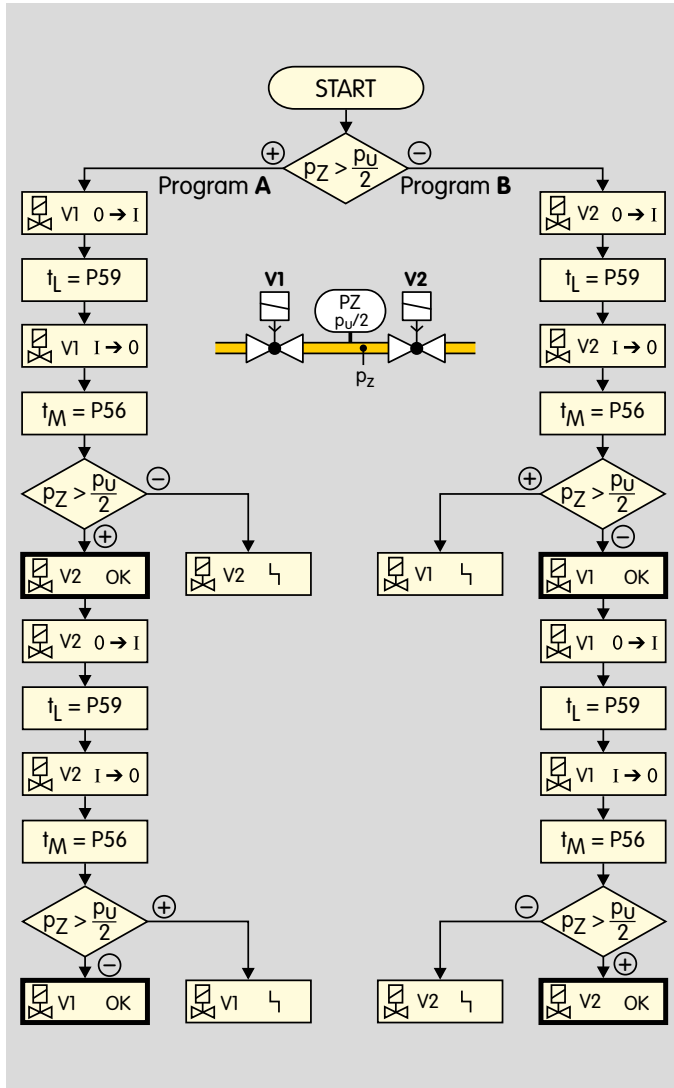

Program B

Valve V2 opens for the set opening time t_L . V2 closes again. During the measurement time t_M , the tightness control checks the pressure p_Z between the valves.

If pressure $p_Z > p_U/2$, valve V1 is leaking.

If pressure $p_Z < p_U/2$, valve V1 is tight. Valve V1 is opened for the set opening time t_L . V1 closes again.

During the measurement time t_M , the tightness control checks the pressure p_Z between the valves.

If pressure $p_Z < p_U/2$, valve V2 is leaking.

If pressure $p_Z > p_U/2$, valve V2 is tight.

The tightness test can only be performed if pressure p_d downstream of V2 is around atmospheric pressure.

5.2 Test period t_p

Depending on the burner capacity, the tightness of the gas solenoid valves must be checked in accordance with the relevant application standard, e.g. EN 676, EN 746, NFPA 85 and NFPA 86.

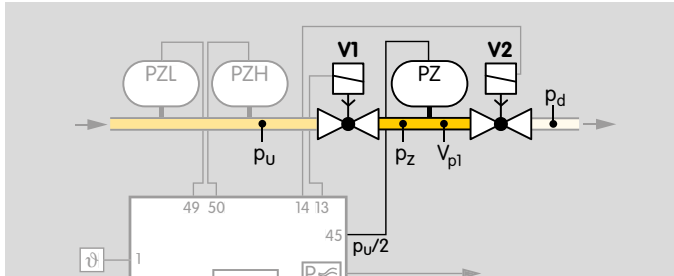

The test period t_p is calculated from:

- Opening times t_L for V1 and V2,
- Measurement times t_M for V1 and V2.

$$t_p \text{ [s]} = 2 \times t_L + 2 \times t_M$$

5.2.1 Extended opening time t_L

Standard EN 1643:2000 allows a maximum opening time of 3 s for the tightness test if the main gas valves are actuated directly. If gas can flow into the combustion chamber when a valve is opened, the gas volume must not exceed 0.05% of the maximum flow rate.

If the pre-set opening time $t_L = 3$ s is inadequate (e.g. if slow opening motorized valves VK are used) to build up or reduce the test volume pressure, bypass valves with an extended opening time may be used (e.g. VAS 1 or bypass valves with an additional orifice). Parameter 52 = 4 must be selected for this.

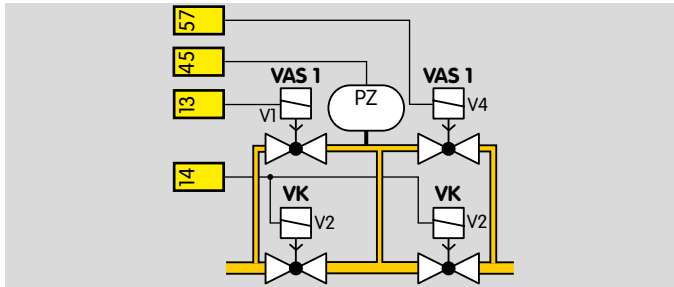

Calculation example

Nominal flow rate $Q_{(N)}$:

P (kW): capacity = 1000 kW

H_u (kWh/m³): lower heating value of gas type = 10 kWh/m³

$$Q_{(N)} \text{ (m}^3\text{/h)} = \frac{P \text{ (kW)}}{H_u \text{ (kWh/m}^3\text{)}}$$

$$Q_{(N)} \text{ (m}^3\text{/h)} = \frac{1000 \text{ kW}}{10 \text{ kWh/m}^3} = 100 \text{ m}^3\text{/h}$$

Max. gas volume in combustion chamber V_O :

$$V_O \text{ (l/h)} = Q_{(N)} \times 0.05\%$$

$Q_{(N)}$ (m³/h): nominal flow rate = 100 m³/h (100,000 l/h)

$$V_O \text{ (l/h)} = 100,000 \text{ l/h} \times 0.05\% = 50 \text{ l/h}$$

Required opening time t_L :

$$t_L \text{ (s)} = \frac{400 \times V_O}{\pi \times d^2 \times 0.7} \times \sqrt{\frac{\rho}{2 \times p_u}}$$

V_O (l/h): max. gas volume in combustion chamber = 50 l/h,

d (mm): orifice diameter of bypass valve = 9.45 mm,

flow factor = 0.7,

p_u (mbar): inlet pressure = 20 mbar,

ρ (kg/m³): density of gas = 0.8 kg/m³

$$t_L \text{ (s)} = \frac{400 \times 50 \text{ l/h}}{3.14 \times 9.45^2 \times 0.7} \times \sqrt{\frac{0.8 \text{ kg/m}^3}{2 \times 20 \text{ mbar}}} = 14.26 \text{ s}$$

Enter the next lowest value for parameter 59 (P59 = 14) to set the opening time, see page 87 (Valve opening time t_{L1}).

Calculation module for calculating the opening time t_L , see page 30 (Calculating the extended opening time)

Calculating the extended opening time

Metric	Imperial
Gas type	
Heating value	
Density ρ	
Capacity P	
Inlet pressure p_u	
Nominal flow rate $Q_{(N)}$	
Max. gas volume in combustion chamber V_O	
VAS 1 on main valve or orifice diameter d	
Opening time t_L	

The calculation module can be used to calculate the opening time t_L for the two bypass valves (e.g. VAS 1 or bypass valves with additional orifice) by entering the gas type, heating value, density, burner heat load, inlet pressure and orifice diameter.

Set the next lowest value for parameter 59 to set the opening time, see page 87 (Valve opening time t_{L1}).

5.2.2 Measurement time t_M

The sensitivity of the tightness control in the BCU can be adjusted for each individual system by adapting the measurement time t_M . The longer the measurement time t_M , the greater the sensitivity of the tightness control. The measurement time is set using parameter 56 to a value between 3 and 3600 s – see page 87 (Measurement time V_{p1}).

The required measurement time t_M is calculated from:

Inlet pressure p_u [mbar]

Leakage rate Q_L [l/h]

Test volume V_{p1} [l]

Calculation of the test volume – see page 32 (Test volume V_{p1})

For one test volume V_{p1} between 2 gas solenoid valves

Adjustable using parameter 56

$$t_M [s] = \left(\frac{2 \times p_u \times V_{p1}}{Q_L} \right)$$

For a large test volume V_{p1} with reduced testing time

Adjustable using parameter 56

$$t_M [s] = \left(\frac{0.9 \times p_u \times V_{p1}}{Q_L} \right)$$

Conversion into US units – see page 109 (Converting units)

Leakage rate

The BCU tightness control makes it possible to check a specific leakage rate Q_L . Within the scope of the European Union, the maximum leakage rate Q_L is 0.1% of the maximum flow rate $Q_{(N)max}$. [m³/h].

$$\text{Leakage rate } Q_L [l/h] = \frac{Q_{(N)max. [m^3/h]} \times 1000 [l/h]}{1000 \times 1 [m^3/h]}$$

Test volume V_{p1}

Test volume V_{p1} is calculated from the valve volume V_V , added to the volume of the pipe V_R for each additional metre in length L .

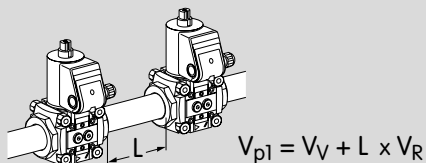

The measurement time required for the test volume V_{p1} must be set on the basis of the calculation using parameter 56.

For the calculation, see page 33 (Calculation examples).

Valves		Pipework	
Type	Volume V_V [l]	DN	Volume per metre V_R [l/m]
VAS 1	0.25	10	0.1
VAS 2	0.82	15	0.2
VAS 3	1.8	20	0.3
VAS 6	1.1	25	0.5
VAS 7	1.4	40	1.3
VAS 8	2.3	50	2
VAS 9	4.3	65	3.3
VG 10	0.01	80	5
VG 15	0.07	100	7.9
VG 20	0.12	125	12.3
VG 25	0.2	150	17.7
VG 40/VK 40	0.7	200	31.4
VG 50/VK 50	1.2	250	49
VG 65/VK 65	2		
VG 80/VK 80	4		
VK 100	8.3		
VK 125	13.6		
VK 150	20		
VK 200	42		
VK 250	66		

Calculation examples

2 valves VAS 665,

distance $L = 9.5$ m,

inlet pressure $p_U = 50$ mbar,

max. flow rate $Q_{(N)\max.} = 200$ m³/h.

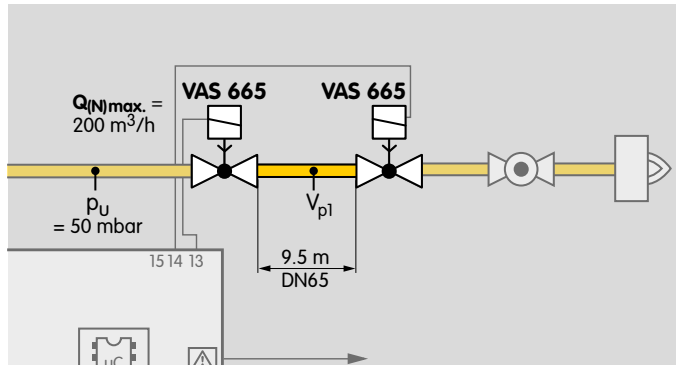

$$\text{Leakage rate } Q_L = \frac{200 \text{ m}^3/\text{h} \times 1000 \text{ l/h}}{1000 \times 1 \text{ m}^3/\text{h}} = 200 \text{ l/h}$$

Test volume $V_{p1} = 1.1 \text{ l} + 9.5 \text{ m} \times 3.3 \text{ l/m} = 32.45 \text{ l}$
see page 32 (Test volume V_{p1})

Measurement time for one test volume V_{p1}

$$t_M [\text{s}] = \frac{2 \times 50 \text{ mbar} \times 32.45 \text{ l}}{200 \text{ l/h}} = 16.23 \text{ s}$$

Set the next highest value (17 s) using parameter 56, see page 87 (Measurement time V_{p1}).

The measurement time can be set to a value between 3 and 3600 s in steps of 1 s.

5.3 Proof of closure function

For applications in the territory covered by NFPA 85 and 86.

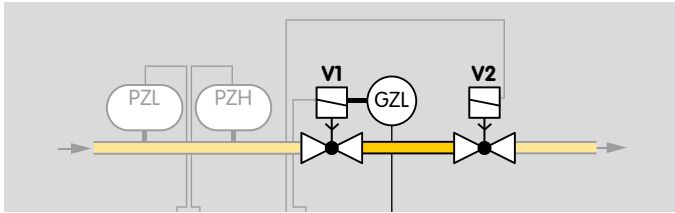

The proof of closure function monitors the function of the gas solenoid valve V1. The proof of closure function can be activated using parameter 51 = 4, see page 86 (Valve proving system).

A limit switch on gas solenoid valve V1 signals the closed position of the valve to the BCU (terminal 45).

5.3.1 Program sequence

When the start-up signal ϑ is received at terminal 1, the BCU checks that valve V1 is in its closed position using the POC switch. If a signal is not received at terminal 45 from the POC switch after a timeout time of 10 s (valve V1 is closed), the BCU performs a fault lock-out with fault message c1.

As soon as the BCU has opened valve V1, it queries the open position of the valve via the POC switch. If a signal is still received at terminal 45 from the POC switch after a timeout time of 10 s, the BCU performs a fault lock-out with fault message c8.

6 BCSoft

BCSoft is an engineering tool for PC's with a Windows operating system. BCSoft makes it possible to set device parameters in order to adjust them to the specific application. BCSoft logs and archives the device parameters. In addition, BCSoft offers further functions. In conjunction with Manual mode, the process values overview provides commissioning support in order to facilitate the commissioning process. In the event of faults or service interventions, details on troubleshooting can be derived from the device statistics and the fault history.



The current version of the engineering tool BCSoft is available at www.docuthek.com.

In addition to the engineering tool BCSoft, an opto-adapter with USB connection or a Bluetooth adapter is required for data transfer between the PC and BCU. If the burner control unit BCU is operated in conjunction with the bus module BCM 500, communication via Ethernet is possible. In this case, the engineering tool BCSoft as of V4xx is required, see page 98 (BCSoft).

7 Fieldbus communication via Ethernet

Profinet and Modbus TCP are manufacturer-independent, open standards for industrial Ethernet. They cover the requirements for automation technology (manufacturing automation, process automation, drive applications without functional safety).

Profinet and Modbus TCP are bus variants for fieldbus communication, optimized for speed and low connection costs.

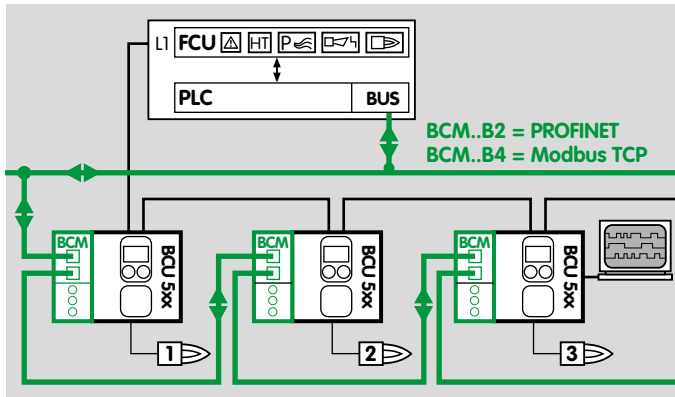

The basic function of Profinet and Modbus TCP is the exchange of process and required data between a controller (e.g. PLC) and several distributed devices (e.g. BCM with BCU/FCU).

The signals from the devices are read into the controller cyclically. There, they are processed and are then output to the devices again.

7.1 BCU and bus module BCM

The optional bus module BCM 500 is required to integrate the BCU in a fieldbus system (Profinet IO or Modbus TCP).

Control signals (for start, reset and air actuator control), signal states from the device inputs and outputs and information about the device status (operating states, flame signal and current program step), warnings and faults can be transferred simultaneously via the bus module between the BCU and PLC.

Bus module BCM 500 has two RJ45 connection sockets for connection to the fieldbus on its front. The connection sockets are combined with an internal 2-port switch. This allows the BCM 500 together with the BCU to be integrated in various network topologies (star, tree or line topology). Requirements such as Auto Negotiation and Auto Crossover are satisfied.



Safety-related signals and interlocks (e.g. safety interlock) must be wired independently of the fieldbus communication direct between the BCU and the protective system (e.g. FCU).

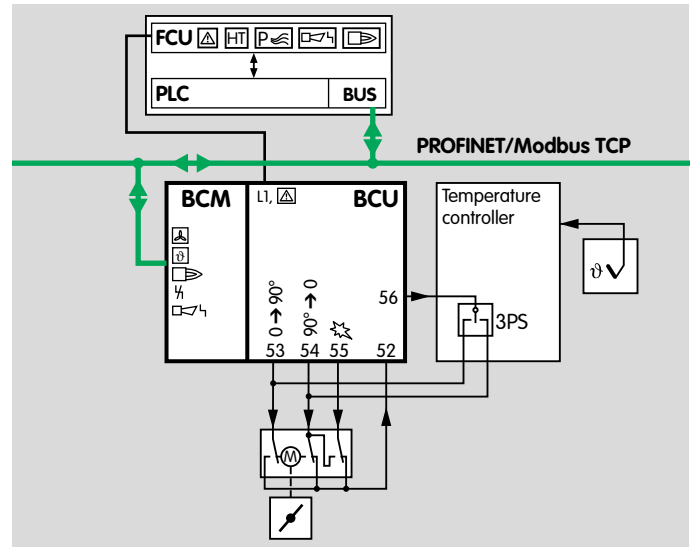

All network components which connect the automation system and the field devices must be certified for the relevant fieldbus use.

For information on planning and the structure of a network and the components to be used (e.g. cables, lines and switches)

for Profinet, see Profinet Installation Guide at www.profibus.com,

for Modbus TCP, see www.modbus.org.

7.2 Configuration, planning

Before commissioning, the bus module must be configured for data exchange with the fieldbus system using an engineering tool or BCSOFT.

To do so, fieldbus communication must be activated on the control unit with connected bus module BCM and the code switches on the BCM set, see also page 92 (Fieldbus communication).

7.2.1 Profinet/Device master data file (GSD)

In addition to cyclic data exchange, Profinet also provides acyclic data exchange for events which are not constantly repeated such as sending device statistics. In the event that the bus communication is faulty or interrupted and during initialization of the bus communication after switching on, the digital signals are interpreted as “0”.

The technical properties of a device are described by the manufacturer in a device master data file (GSD file).

The GSD file is required for integration of the device (BCU/FCU) in the configuration of the PLC. The GSD file contains the device image, the communications properties and all fault messages from the device in text form which are important for the configuration of the Profinet network and the data exchange. Modules defined in the GSD file may be selected for configuration to integrate the device. The GSD file for the bus module can be ordered at www.docuthek.com.

The steps required to integrate the file are described in the instructions for the engineering tool for your automation system.

7.2.2 Modbus TCP

The Modbus protocol is a communications protocol based on a Client/Server architecture. Once the TCP/IP connection between client (PLC) and server (BCU/FCU) has been established, useful data can be transferred via this connection as often and in as great an amount as required. The PLC and BCU/FCU can establish up to 3 parallel TCP/IP connections at the same time. Using the function codes 3, 6 and 16, data can be transferred to and from the BCU/FCU.

The PLC must send output data to the BCU/FCU at least every 125 ms in order to ensure data transfer and functioning of the BCU/FCU. If the output data is missing or sent too late, the bus module will interpret them as “0”.

7.2.3 Modules/Registers for process data

All modules (Profinet) and registers (Modbus TCP) required for data exchange between the PLC and the burner control unit BCU 570 are shown in the following table.

Module (Profinet) Register (Modbus TCP)	Profinet slot	Modbus address	Address	Operation
Outputs	1	0	n	w
Inputs		6 ¹⁾	n...n+1	r
Burner 1 flame signal	2	9	n	r
Status signal	3	12	n	r
Fault and warning signals	4	15	n...n+1	r
Remaining times	5	18	n	r
TC remaining times ²⁾	6	21	n...n+1	r
PLC output terminal information	7	24	n	r
BCU input terminal information	8	27	n...n+1	r
BCU output terminal information	9	30	n...n+1	r

¹⁾ Modbus TCP: see table Modbus TCP – register structure

²⁾ Only for BCU..C1. Slot 7/address 24 is not transferred with other device versions.

Modbus TCP – register structure

Example of “Inputs” register:

Modbus address	6		7	
Format	Word		Word	
PLC address byte	Byte n .7 .0	Byte n+1 .7 .0	Byte n+2 .7 .0	Byte n+3 .7 .0



Inputs/Outputs

The digital input and output signals from the burner control unit BCU 570 are included in this module/register.

Input bytes (BCU → PLC)

The input bytes describe the digital signals which are transferred from the BCU to the digital inputs of the PLC. The digital signals take up 3 bytes (24 bits).

Bit	Byte n	Byte n+1	Format
0	Burner 1 operating signal	Max. capacity reached ¹⁾	BOOL
1	Free	Min. capacity reached ¹⁾	BOOL
2	BCU system fault	Free	BOOL
3	Fault lock-out	Free	BOOL
4	Safety shut-down	Free	BOOL
5	Warning	Free	BOOL
6	ON	Free	BOOL
7	Manual mode	Burner 1 flame signal	BOOL

¹⁾ Only with three-point step control via bus.

Output byte (PLC → BCU)

The output byte describes the digital signals which are output by the PLC to the BCU. The digital signals to control the burner control unit BCU occupy 1 byte (8 bits).

Parallel to the bus communication, terminals 1 to 3 of the BCU can be wired. This allows the BCU to be controlled using the digital signals of the bus communication or the inputs at the terminals.

Bit	Byte n	Format
0	Reset ¹⁾	BOOL
1	Burner 1 start ¹⁾	BOOL
2	External air ON ¹⁾	BOOL
3	Free	BOOL
4	Free	BOOL
5	Free	BOOL
6	Open control element, three-point step Open ²⁾	BOOL
7	Close control element, three-point step Close ²⁾	BOOL

¹⁾ Parallel to the bus communication, terminals 1 to 4 can be wired.

²⁾ Only with three-point step control via bus.

Burner 1 flame signal (BCU → PLC)

The flame signal for burner 1 is transferred from the BCU to the PLC as an analogue value using this module/register. The flame signal occupies one byte with values from 0 to 255 (= flame signal from 0 to 25.5 μA).

Bit	Byte n	Data type	Format	Value
0	Burner 1 flame signal	Byte	DEC	0 – 255 ¹⁾ (0 – 25.5 μA)
1				
2				
3				
4				
5				
6				
7				

¹⁾ See code tables “GSD Codes BCU 570” or “Modbus Profile BCU 570” at www.docuthek.com

Status signal (BCU → PLC)

This module/register transfers the status signals from the BCU to the PLC. The status signals occupy one byte (0 to 255). Every status signal is allocated a code. The allocation is described in the code table “BCU570_GSD_Codetabelle.xlsx”.

Bit	Byte n	Data type	Format	Value
0	Status signals	Byte	DEC	0 – 255 ¹⁾
1				
2				
3				
4				
5				
6				
7				

¹⁾ See code tables “GSD Codes BCU 570” or “Modbus Profile BCU 570” at www.docuthek.com

Fault and warning signals (BCU → PLC)

The fault and warning signals are transferred from the BCU to the PLC using this module/register. The fault and warning signals occupy one byte each (0 to 255). The same allocation table applies to the fault signals and the warning signals.

Bit	Byte n	Data type	Format	Value
0	Fault signals	Byte	DEC	0 – 255 ¹⁾
1				
2				
3				
4				
5				
6				
7				

Bit	Byte n+1	Data type	Format	Value
0	Warning signals	Byte	DEC	0 – 255 ¹⁾
1				
2				
3				
4				
5				
6				
7				

¹⁾ See code tables “GSD Codes BCU 570” or “Modbus Profile BCU 570” at www.docuthek.com

Remaining times (BCU → PLC)

This module/register transfers the remaining times of various processes from the BCU to the PLC. The remaining time occupies 2 bytes.

Bit	Byte n	Byte n+1	Data type	Format	Value
0	Remaining times		Word	DEC	0 - 6554 (0 - 6554 s)
1					
2					
3					
4					
5					
6					
7					

Remaining times of the valve proving system (BCU → PLC)

Only for BCU..C1.

The module/register in BCU..C0 contains no information.

This module/register transfers the remaining time of the valve proving system from the BCU..C1 to the PLC. The remaining time occupies 2 bytes.

The valve check runs parallel to other time-related processes, e.g. pre-purge. To display the remaining time of the valve proving system separately, it is transferred separately.

Bit	Byte n	Byte n+1	Data type	Format	Value
0	Remaining times of the valve proving system		Word	DEC	0 - 6554 (0 - 6554 s)
1					
2					
3					
4					
5					
6					
7					

PLC output information (BCU → PLC)

This module/register transfers information on signals which the PLC uses to control the BCU back to the PLC. This allows the signal transfer from the PLC to the BCU to be checked.

Bit	Byte n	Format
0	Reset	BOOL
1	Burner 1 start	BOOL
2	External air ON	BOOL
3	Free	BOOL
4	Free	BOOL
5	Free	BOOL
6	Open control element, three-point step Open ¹⁾	BOOL
7	Close control element, three-point step Close ¹⁾	BOOL

¹⁾ Only with three-point step control via bus.

BCU input terminal information (BCU → PLC)

This module/register transfers the signal states of the digital inputs on the BCU (input terminals) to the PLC.

Bit	Byte n	Byte n+1	Format
0	Terminal 1	Terminal 50	BOOL
1	Terminal 2	Terminal 51	BOOL
2	Terminal 3	Terminal 52	BOOL
3	Terminal 45	Terminal 65	BOOL
4	Terminal 46	Terminal 66	BOOL
5	Terminal 47	Terminal 67	BOOL
6	Terminal 48	Terminal 68	BOOL
7	Terminal 49	Free	BOOL

BCU output terminal information (BCU → PLC)

This module/register transfers the signal states of the digital outputs on the BCU (output terminals) to the PLC.

Bit	Byte n	Byte n+1	Format
0	Terminal 9	Terminal 55	BOOL
1	Terminal 13	Terminal 56	BOOL
2	Terminal 14	Terminal 57	BOOL
3	Terminal 15	Terminal 58	BOOL
4	Terminal 17/18	Free	BOOL
5	Terminal 37/38	Free	BOOL
6	Terminal 53 ¹⁾	Free	BOOL
7	Terminal 54	Free	BOOL

¹⁾ Only for BCU..F2: terminal 53 is used as an input.
Bit 2 has no function.

7.2.4 Device parameters and statistics

Profinet

With the help of acyclic communication between the PLC and BCU, it is possible to read information on parameters, statistics and fault history on an event basis (e.g. using system function block Siemens FSB 52 RDREC).

Index	Description
1001	Parameters
1002	Device statistics, counter
1003	Device statistics, faults/warnings
1004	Operator statistics, counter
1005	Operator statistics, faults/warnings
1006	Fault history
1007	Power module statistics

The available data records differ in terms of their indexes. The contents and description of the indexes are described in the code table “GSD Codes BCU 570” (download from www.docuthek.com).

Modbus TCP

Address	Description
256 - 511	Parameters
512 - 767	Device statistics, counter
768 - 1023	Device statistics, faults/warnings
1024 - 1279	Operator statistics, counter
1280 - 1535	Operator statistics, faults/warnings
1536 - 1791	Fault history
1792 - 2047	Power module statistics

The available data records differ in terms of their addresses. The contents and description of the addresses are described in the code table “Modbus Profile BCU 570” (download from www.docuthek.com).

8 Program step/status

DISPLAY	Program step/status
00	Start-up position/standby
H0	Delay
01	Fan run-up time t_{GV}
d0	"No flow" state check of low air pressure protection device
d1	Low air pressure protection check
Rc	Approaching minimum capacity/closed position
Ro	Approaching maximum capacity
P1	Pre-purge
Ri	Approaching ignition capacity
H2	Delay
tc	Valve check
03	Pre-ignition time t_{VZ}
04	Safety time 1 t_{SA1}
05	Flame proving period 1 t_{FS1}
06	Safety time 2 t_{SA2}
07	Flame proving period 2 t_{FS2}
H8	Delay
08	Operation/controller enable
09	Over-run up to minimum capacity
P9	Post-purge
C1	Controlled air flow
U1	Remote control with OCU
LP	Data transfer (programming mode)
--	Device Off

In Manual mode, two dots blink on the display.

9 Fault signalling

Fault message (blinking)	DISPLAY	Description
Flame simulation	01	Flame signal before ignition
No flame after safety time 1	04	No flame formation to end of 1 st safety time
Flame failure during flame proving period 1 t_{FS1}	05	
Flame failure during safety time 2 t_{SA2}	06	No flame formation to end of 2 nd safety time
Flame failure during flame proving period 2 t_{FS2}	07	
Flame failure during operation	08	
Too many remote resets	10 ¹⁾	Remote reset activated > 5 × in 15 min.
Too many restarts	11	> 5 restarts in 15 minutes
Controller enable output (terminal 56)	20 ¹⁾	Controller enable output incorrectly connected
Simultaneous activation (terminals 51 and 52)	21 ¹⁾	"Maximum capacity" and "Ignition capacity" position feedback from butterfly valve set simultaneously
Actuator wiring (terminals 52 – 55)	22	Faulty wiring of terminals 52 to 55
Actuator feedback (terminal 52)	23 ¹⁾	Maximum or ignition capacity is not constantly signalled back to terminal 52
Simultaneous Min./Max. bus command	24 ¹⁾	"Open actuator" and "Close actuator" bus signals set simultaneously
Non-fail-safe parameters (NFS) inconsistent	30 ¹⁾	NFS parameter range is inconsistent
Fail-safe parameters (FS) inconsistent	31 ¹⁾	FS parameter range is inconsistent
Mains voltage	32 ¹⁾	Operating voltage too high/low
Faulty parameterization	33 ¹⁾	Parameter set contains illegal settings
Incompatible bus module	35	
Power module defective	36 ¹⁾	Relay contact fault caused by EMC influence and by applying voltage to outputs or by an incorrect load module
Inlet valve(s) leaking	40	Leak found on inlet valve
Outlet valve(s) leaking	41	Leak found on outlet valve

Fault signalling

Fault message (blinking)	DISPLAY	Description
Controller enable/emergency stop	50 ³⁾	No signal at the controller enable/emergency stop input
Fuse defective	51 ¹⁾	
Permanent remote reset	52 ¹⁾	Remote reset input activated > 25 s
Timing cycle too short	53	Minimum timing cycle not observed
Internal error	80 ¹⁾	Device error
Internal error	89 ¹⁾	Error in processing internal data
Internal error	94 ¹⁾	Error at digital inputs
Internal error	95 ¹⁾	Error at digital outputs
Internal error	96 ¹⁾	Error when checking the SFR
Internal error	97 ¹⁾	Error when reading the EEPROM
Internal error	98 ¹⁾	Error when writing to the EEPROM
emBoss	99 ¹⁾	Shut-down without application error
Minimum capacity not reached	Ac	Position for minimum capacity has not been reached after 255 s
Maximum capacity not reached	Ad	Position for maximum capacity has not been reached after 255 s
Ignition capacity not reached	Al	Position for ignition capacity has not been reached after 255 s
Communication with bus module	bE ¹⁾	Bus module fault
Parameter chip card (PCC)	bC ¹⁾	Incorrect or defective PCC
POC valve open	c1	Valve not closed
POC valve closed	c8	Valve not open
Air monitor "no flow" state	d0	Fault Air monitor "no flow" state check. The signal from the pressure switches is received at terminal 47 or 48 before the fan is switched on.
Low air pressure (display d1, d2, d3, d4, d5, d6, d7, d8 or d9)	d1 d2 d3 d4 d5 d6 d7 d8 d9 ³⁾	No input signal from pressure switch or failure in air supply during program step 1, 2, 3, 4, 5, 6, 7, 8 or 9

Fault signalling

Fault message (blinking)	DISPLAY	Description
Air flow during pre-purge		Air flow failure during pre-purge
Waiting for connection		BCU waiting for connection to controller
Invalid address		Invalid or incorrect address set on bus module
Invalid configuration		The bus module has received an incorrect configuration from the controller
Invalid network name		Invalid or no address allocated in the network name
Controller in STOP position		Controller in STOP position
High gas pressure (display o0, o1, o2, o3, o4, o5, o6, o7, o8 or o9)		No input signal from pressure switch at terminal 50 during program step 0, 1, 2, 3, 4, 5, 6, 7, 8 or 9
Low gas pressure (display u1, u2, u3, u4, u5, u6, u7, u8 or u9)		No input signal from pressure switch at terminal 49 during program step 1, 2, 3, 4, 5, 6, 7, 8 or 9

¹⁾ System faults can only be acknowledged using the Reset/Information button on the BCU.

²⁾ The BCU shows a warning message on the display. The BCU can continue to be operated via the control inputs.

³⁾ If fault lock-out has been programmed, the fault must be acknowledged using the Reset/Information button.

If safety shut-down has been programmed, no fault signal is sent via the fault signalling contact. As soon as the fault no longer exists, the fault message on the display disappears. Acknowledging the fault using the Reset/Information button is not necessary.

10 Parameter

Any changes to parameters will be saved to the parameter chip card.

Name	Parameter	Value range	Description	Factory default settings
Burner 1 FS1 flame signal switch-off threshold	01	2 – 20	Burner 1 flame signal switch-off threshold in μA , depending on P04: P04 = 0: 2 – 20 μA , P04 = 1: 5 – 20 μA , P04 = 2: 5 μA	5
Flame control	04	0 1 2	Flame rod UVS sensor UVD sensor	0
Burner 1 start-up attempts	07	1 2 3	1 start-up attempt 2 start-up attempts 3 start-up attempts	1
Restart	09	0 1 4	Off Burner 1 Max. 5 x in 15 min. for burner 1	0
Emergency stop	10	0 1 2	Off With safety shut-down With fault lock-out	2
High gas pressure protection	12	0 1 2	Off With safety shut-down With fault lock-out	2
Low gas pressure protection	13	0 1 2	Off With safety shut-down With fault lock-out	2
Low air pressure protection	15	0 1 2	Off With safety shut-down With fault lock-out	2
Safety time during operation t_{SG}	19	1; 2	Time in seconds	1
Fan run-up time t_{GV}	30	0 – 6000	Time in seconds	0
Air monitoring during controlled air flow	32	0 1 2	Off; maximum capacity On; maximum capacity Off; controller enable	1

Parameter

Name	Parameter	Value range	Description	Factory default settings
Start-up with pre-purge after controlled shut-down within 24 hours	33	0 1 2 3 4	On (depending on P34 Pre-purge time t_{PV}) Off; no air control Off; start from position for ignition capacity Off; start from minimum capacity/closed position Off; start from position for minimum capacity	0
Pre-purge time t_{PV}	34	0 – 6000	Time in seconds	6000
Air flow monitoring during pre-purge	35	0 1 2	Off With safety shut-down With fault lock-out	2
Post-purge time t_{PN}	37	0 – 6000	Time in seconds	6000
Air flow monitoring during post-purge	38	0 1 2 3	On; control element to maximum capacity Off; control element to maximum capacity Off; control element to ignition capacity Off; control element controller enable	1
Capacity control	40	0 1 2 3 4	Off With IC 20 With IC 40 With RBW With frequency converter	BCU..F1 = 1 BCU..F2 = 3
Running time selection	41	0 1 2 3	Off; checking the positions for minimum/maximum capacity On; for approaching the positions for minimum/maximum capacity On; for approaching the position for maximum capacity On; for approaching the position for minimum capacity	0
Running time	42	0 – 250	Running time in seconds if parameter 41 = 1, 2 or 3	30
Low fire over-run	43	0 1	Off Up to minimum capacity	0
Controller enable signal delay time t_{RF}	44	0 – 250	Time in seconds	0
Valve proving system	51	0 1 2 3 4	Off Tightness test before start-up Tightness test after shut-down Tightness test before start-up and after shut-down Proof of closure function	0

Parameter

Name	Parameter	Value range	Description	Factory default settings
Relief valve (VPS)	52	2 3 4	V2 V3 V4	2
Measurement time V_{p1}	56	3 5 – 25 30 – 3600	Time in seconds (in 5 s steps) (in 10 s steps)	3600
Valve opening time t_{L1}	59	2 – 25	Time in seconds	2
Minimum operating time t_B	61	0 – 250	Time in seconds	0
Minimum pause time t_{MP}	62	0 – 3600	Time in seconds	0
Switch-on delay time t_E	63	0 – 250	Time in seconds	0
Operating time in Manual mode	67	0 1	Unlimited 5 minutes	1
Function of terminal 51	69	0 8 9 10 11 12 13	Off AND with emergency stop (trm. 46) AND with air _{min} (trm. 47) AND with air flow monitoring (trm. 48) AND with gas _{max} (trm. 50) AND with gas _{min} (trm. 49) Max. capacity position feedback (IC 40/RBW)	0
Function of terminal 65	70	0 8 9 10 11 12	Off AND with emergency stop (trm. 46) AND with air _{min} (trm. 47) AND with air flow monitoring (trm. 48) AND with gas _{max} (trm. 50) AND with gas _{min} (trm. 49)	0
Function of terminal 66	71	0 8 9 10 11 12	Off AND with emergency stop (trm. 46) AND with air _{min} (trm. 47) AND with air flow monitoring (trm. 48) AND with gas _{max} (trm. 50) AND with gas _{min} (trm. 49)	0
Function of terminal 67	72	0 8 9 10 11 12	Off AND with emergency stop (trm. 46) AND with air _{min} (trm. 47) AND with air flow monitoring (trm. 48) AND with gas _{max} (trm. 50) AND with gas _{min} (trm. 49)	0

Parameter

Name	Parameter	Value range	Description	Factory default settings
Function of terminal 68	73	0 8 9 10 11 12	Off AND with emergency stop (trm. 46) AND with air _{min.} (trm. 47) AND with air flow monitoring (trm. 48) AND with gas _{max.} (trm. 50) AND with gas _{min.} (trm. 49)	0
Capacity control (bus)	75	0 1 2 3 4 5	Off MIN-MAX/MIN MIN-MAX/CLOSED IGNITION-MAX/CLOSED MIN-MAX/MIN + quick start IGNITION-MAX/CLOSED + quick start	0
Password	77	0000 – 9999	Four-digit number code	1234
Burner application	78	0 1 2 3	Burner 1 Burner 1 with pilot gas Burner 1 and burner 2 Burner 1 and burner 2 with pilot gas	0
Pilot burner	79	0 1	With shut-down In continuous operation	0
Fieldbus communication	80	0 1 2	Off With address check No address check	1
Pre-ignition time t_{VZ}	93	0 – 5	Time in seconds	1
Safety time 1 t_{SA1}	94	2, 3, 5, 10	Time in seconds	5
Flame proving period 1 t_{FS1}	95	0 – 20	Time in seconds	2
Safety time 2 t_{SA2}	96	2, 3, 5, 10	Time in seconds	3
Flame proving period 2 t_{FS2}	97	0 – 20	Time in seconds	2

10.1 Scanning the parameters

During operation, the 7-segment display shows the program step/status.

In addition to the flame signal and the fault history, all the parameters of the BCU can be scanned in numerical order by repeatedly pressing the Reset/Information button (for 1 s).

The parameter display is ended 60 seconds after the last time the button is pressed or by switching off the BCU.

The BCU indicates  when the mains switch has been switched off. The parameters cannot be scanned when the BCU is switched off or when a fault or warning is displayed.

10.2 Flame control

The BCU is fitted with a flame amplifier which evaluates whether an adequate flame signal is supplied by the burner using a flame rod or UV sensor.

10.2.1 Burner 1 FS1 flame signal switch-off threshold

Parameter 01

The sensitivity at which the burner control unit detects a flame can be set using parameter 01.

As soon as the measured flame signal falls below the set value (2 to 20 μ A), the BCU performs a fault lock-out during start-up after the elapse of the safety time or

during operation after the elapse of the safety time during operation (parameter 19).

In the case of UV control, this value can be increased, should the burner to be monitored be influenced by other burners for example.

10.2.2 Flame control

Parameter 04

Parameter 04 = 0: flame control is performed with a flame rod.

Parameter 04 = 1: flame control is performed with a UV sensor for intermittent operation (UVS). To meet the normative requirements for intermittent operation, the burner is shut down and restarted automatically after a continuous operating time of 24 hours. This shut-down and subsequent restart are performed in the same way as a normal controlled shut-down. Depending on the parameterization, the burner is started with or without pre-purge. This process is controlled independently by the BCU and therefore it must be checked whether the industrial process permits the pause in heat supply it creates.

Parameter 04 = 2: flame control is performed with a UV sensor for continuous operation (UVC).

The reaction times of the BCU and UV sensor for continuous operation are coordinated so that the set safety time during operation (parameter 19) is not extended.

10.3 Behaviour during start-up

10.3.1 Burner 1 start-up attempts

Parameter 07

This parameter defines the maximum number of possible start-up attempts of the burner.

Taking into account national standards and requirements, it must be clarified whether multiple start-up attempts are permitted.

If no flame is detected during start-up, an immediate fault lock-out (P07 = 1) or up to two additional start-up attempts (P07 = 2, 3) are performed depending on parameter 07.

Parameter 07 = 1: 1 start-up attempt. If no flame is formed during the start-up, so that at the end of the safety time t_{SA1} or t_{SA2} no flame signal is detected, this will result in a BCU safety shut-down with subsequent fault lock-out. The fault message 04 or 05, depending on the burner operating mode, will flash in the BCU display.

Parameter 07 = 2, 3: 2 or 3 start-up attempts. If no flame is formed during the start-up, so that at the end of the safety time t_{SA1} no flame signal is detected, the BCU closes the gas valves and repeats the start-up. Each start-up attempt begins with the parameterized start-up behaviour.

If safety time t_{SA1} or t_{SA2} elapses without a flame signal having been detected, even after the last parameterized

start-up attempt, this will result in a BCU safety shut-down with subsequent fault lock-out. The fault message 04 or 05, depending on the burner operating mode, will flash in the BCU display.

If the parameters for the limits of High gas pressure protection, Low gas pressure protection, Low air pressure protection or Air flow monitoring during pre-purge are set to safety shut-down (P12, P13, P15 or P35 = 1) and there is no signal at the input for the relevant limit (terminal 47, 48, 49 or 50), depending on parameter 07 an immediate fault lock-out (P07 = 1) or up to two additional start-up attempts (P07 = 2, 3) will take place.

10.3.2 Start-up with pre-purge after controlled shut-down within 24 hours

Parameter 33

Parameter 33 determines whether the BCU activates pre-purge after a controlled shut-down before a fresh burner start and in what position the actuator stays during standby. The requirement for this is that the last controlled shut-down took place within the last 24 hours.

If parameter 33 = 1, 2 or 3, pre-purge is not required for a start-up after a controlled shut-down within the last 24 hours. After switching on the BCU (mains on), after a safety shut-down or fault lock-out and after a controlled shut-down more than 24 hours previously, the BCU will always perform a pre-purge.

Parameter 33 = 0: On (depending on P34 Pre-purge time t_{PV}). The BCU starts a pre-purge for every start-up for the time fixed in parameter 34.

Parameter 33 = 1: Off; no air control. No control element is connected to the BCU (parameter 40 = 0). Pre-purge is deactivated.

Parameter 33 = 2: Off; start from position for ignition capacity. If the start-up takes place within 24 hours of the last controlled shut-down, pre-purge is suppressed. The actuator is in the position for ignition capacity during standby (after a controlled shut-down).

Parameter 33 = 3: Off; start from minimum capacity/closed position. If the start-up takes place within 24 hours of the last controlled shut-down, pre-purge is suppressed. The actuator is in the position for minimum capacity during standby (after a controlled shut-down). Starting up without pre-purge (quick start, P33 = 1, 2, 3) prevents air flowing into the combustion chamber unnecessarily. This accelerates the burner start-up.

Taking into account national standards and requirements, it must be clarified whether the quick start option without pre-purge may be used.

10.3.3 Burner application

Parameter 78

This parameter enables the BCU to be adjusted to various burner applications. In principle, a distinction is made between applications with a burner ($P78 = 0$) and burners with a gas pilot ($P78 = 2$). In both applications, an optional pilot gas valve (V3) can be parameterized via which the burner is started with a defined ignition capacity.

Parameter 78 = 0: burner 1. Two valves (V1, V2) are included for a modulating, directly ignited burner. These are connected to the valve outputs (terminals 13 and 14). Valves V1 and V2 are opened in parallel to start the burner in order to release the gas supply to the burner.

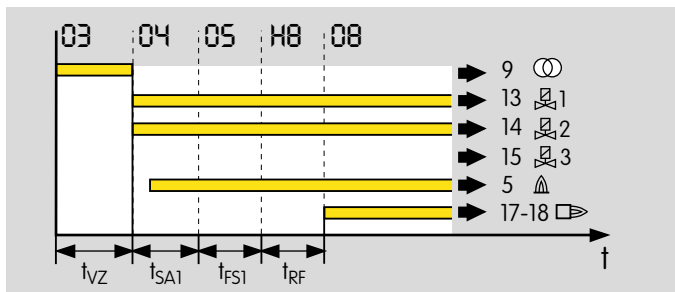
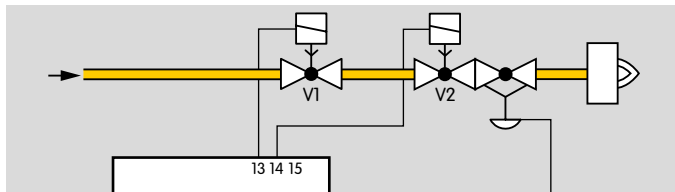

Parameter 78 = 1: burner 1 with pilot gas. Three valves (V1, V2 and V3) are included for a modulating, directly ignited burner with a pilot gas valve. These are connected to the valve outputs (terminals 13, 14 and 15). Valves V1 and V3 open to start the burner. The burner is started with a limited ignition capacity using gas valve V3. After the elapse of the safety time t_{SA1} (program step 04), valve V2 opens. After the elapse of the flame proving period t_{FS1} (program step 05), it is closed again.

For this application, it must be ensured that the flame proving period (P95) is set to a value ≥ 2 s.

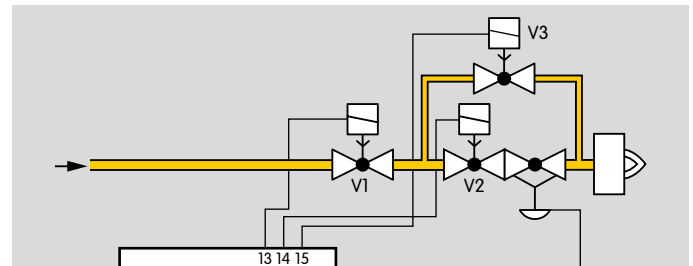

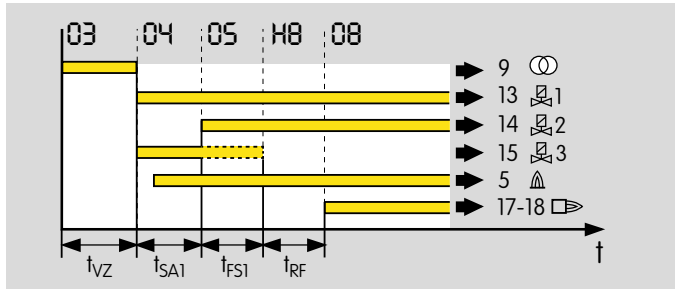

Parameter 78 = 2: burner 1 and burner 2. Three valves (V1, V2 and V4) are included for a modulating burner with a gas pilot. These are connected to the valve outputs (terminals 13, 14 and 57). Valves V1 and V4 open to start the gas pilot. Gas valve V2 releases the gas supply to the main burner.

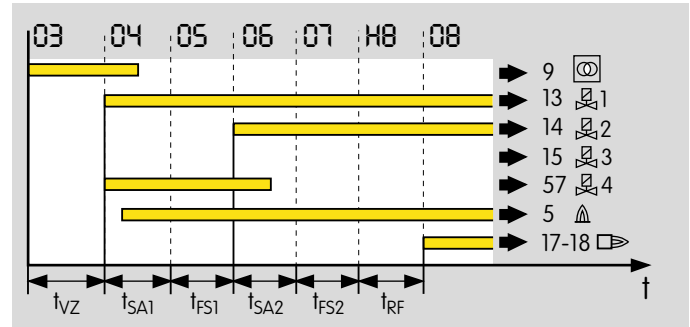
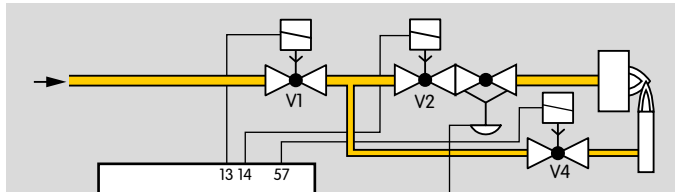

Parameter 78 = 3: burner 1 and burner 2 with pilot gas. In this application, the burner has an additional pilot gas valve V3. The valves are connected to the valve outputs (terminals 13, 14, 15 and 57). Valves V1 and V4 open to start the gas pilot. The burner is started with a limited ignition capacity using gas valve V3. After the elapse of the safety time t_{SA2} (program step 06), valve V2 opens (terminal 14). Valve V3 is closed again after the elapse of the flame proving period t_{FS2} (program step 07).

For this application, it must be ensured that the flame proving period (P97) is set to a value ≥ 2 s.



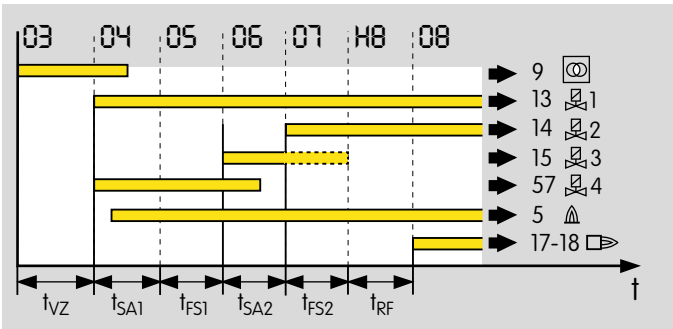
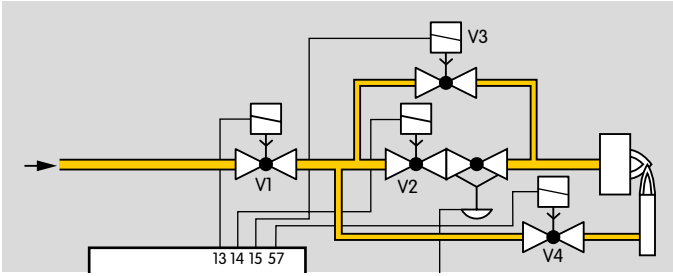

10.3.4 Pre-ignition time t_{VZ}

Parameter 93

The ignition is activated at the start of the pre-ignition time (0 to 5 s). The valves are closed during the pre-ignition time. The ignition spark can stabilize in the air flow. Only after the pre-ignition time has ended will the valves be opened to ignite the flame. The safety time on start-up is then started after the end of the pre-ignition time.

10.3.5 Safety time 1 t_{SA1}

Parameter 94

During safety time 1 t_{SA1} , the flame (pilot flame) is ignited. It can be set to 2, 3, 5 or 10 s.

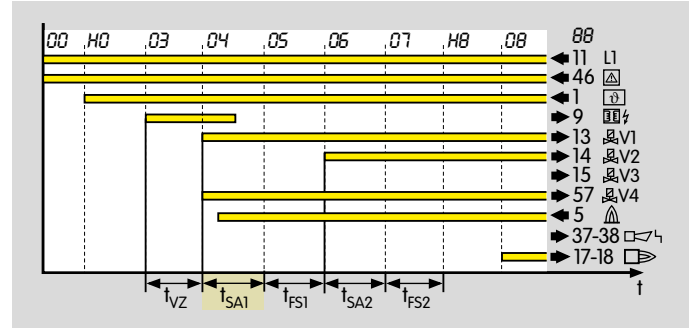

Safety time 1 is started after the end of the pre-ignition time t_{VZ} . Valves V1 and V4 open at the start of safety time 1. The fuel supply to burner 1 (gas pilot) is released so that a flame can form. If no flame is detected at the end of safety time 1, the valves are closed again. Depending on parameter 07 (Burner 1 start-up attempts), the BCU reacts either with an immediate safety shut-down with fault lock-out ($P07 = 1$) or with up to two additional start-up attempts ($P07 = 2$ or 3). The BCU will complete a maximum of three start-up attempts.



Parameter

Safety time 1 must be determined on the basis of current national standards and regulations. The burner application and the burner capacity are the main criteria for this.

If signals ϑ (terminal 1) or $\text{Gas}_{\min.}$ (terminal 49) drop out during safety time 1, the valves will not be switched off until the end of safety time 1.

10.3.6 Flame proving period 1 t_{FS1}

Parameter 95

Flame proving period 1 (t_{FS1}) can be parameterized to enable the flame on burner 1 to stabilize after the elapse of safety time 1. Only when the flame proving period has elapsed will the next program steps be initiated by the BCU. The flame proving period can be set between 0 and 20 s.

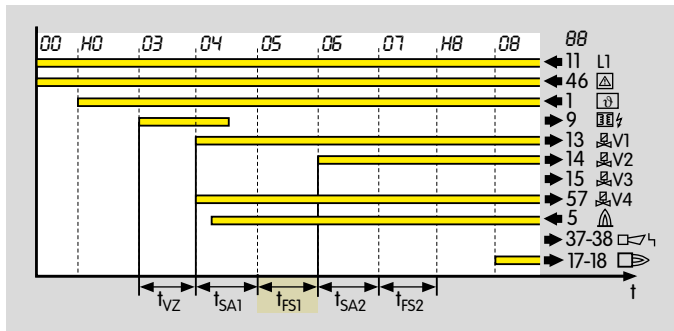

If parameter 78 = 1 has been selected (burner with pilot gas), flame proving period 1 will automatically be set to min. 2 s.

10.3.7 Safety time 2 t_{SA2}

Parameter 96

During safety time 2 t_{SA2} , the flame on burner 2 (main flame) is ignited. It can be set to 2, 3, 5 or 10 s.

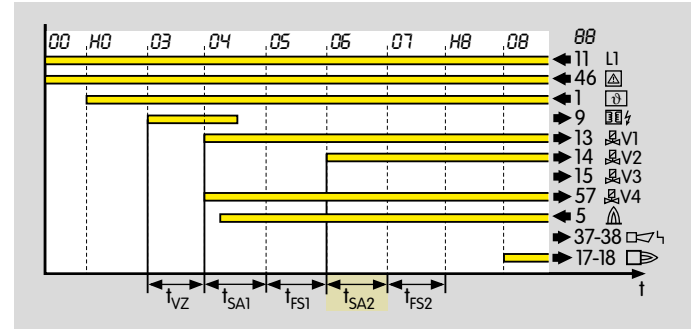

Valve V2 opens at the start of safety time 2. The fuel supply to burner 2 is released so that a flame can form. If no flame is detected at the end of safety time 2, the valves are closed again. Depending on parameter 08 (Burner 2 start-up attempts), the BCU reacts either with an immediate safety shut-down with fault lock-out (P08 = 1) or with up to two additional start-up attempts (P08 = 2 or 3). The BCU will complete a maximum of three start-up attempts.



Safety time 2 must be determined on the basis of current national standards and regulations. The burner application and the burner capacity are the main criteria for this.

If signals ϑ (terminal 1) or Gas_{min} (terminal 49) drop out during safety time 2, the valves will not be switched off until the end of safety time 2.

10.3.8 Flame proving period 2 $t_{\text{FS}2}$

Parameter 97

Flame proving period 2 $t_{\text{FS}2}$ can be parameterized to enable the flame on burner 2 to stabilize after the elapse of safety time 2. Only when the flame proving period has elapsed will the next program steps be initiated by the BCU. The flame proving period can be set between 0 and 20 s.

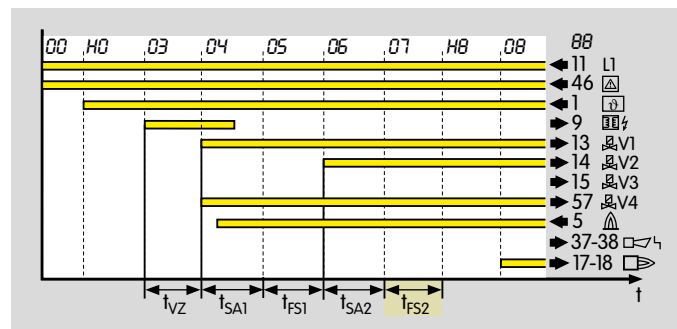

If parameter 78 (Burner application) = 3 has been selected (burner with pilot gas), flame proving period 2 ($t_{\text{FS}2}$) will automatically be set to min. 2 s.

10.4 Behaviour during operation

10.4.1 Restart

Parameter 09

Restart can be programmed for burners which occasionally display unstable behaviour during operation.

This parameter determines whether the BCU initiates an immediate fault lock-out or an automatic restart after a safety shut-down during operation. Excessive restarts, however, can be detected.

Taking into account national standards and requirements, it must be clarified whether the restart function may be used.

In the event of a restart after a safety shut-down, post-purge occurs if a post-purge time (P37) has been programmed. Then the combustion air fan is switched off and the program sequence starts from the start-up position (display $\square\square$).

Parameter 09 = 0: Off.

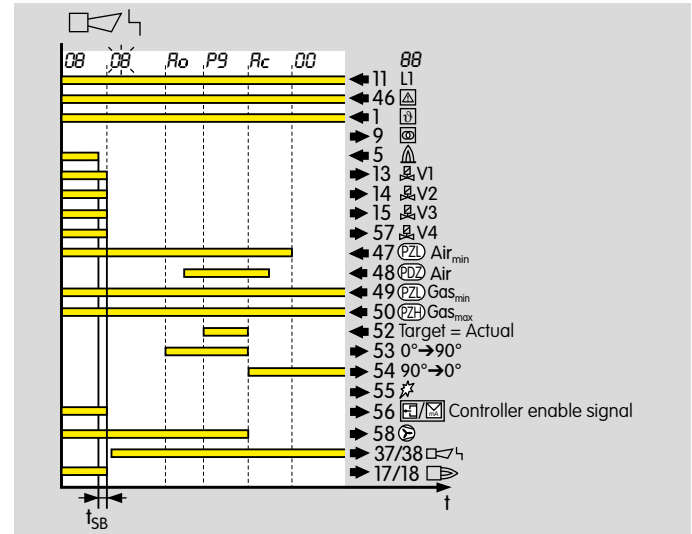

A safety shut-down with subsequent fault lock-out takes place in the event of flame failure during operation. Post-purge occurs if a post-purge time has been programmed.

Parameter O9 = 1: burner 1. The restart function is active.

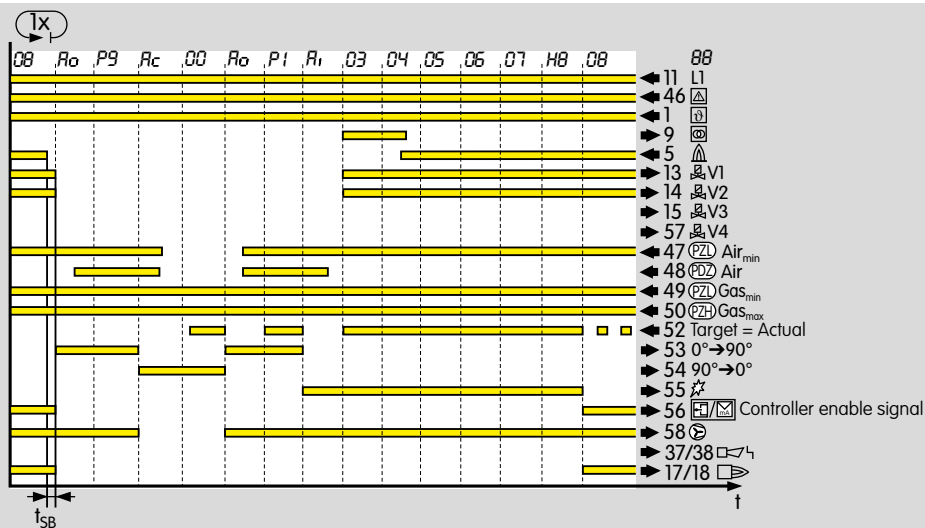

If a safety shut-down occurs during operation (minimum operating time of 2 s), the valves are closed and the operation signalling contact is opened within the safety time during operation t_{SB} . Post-purge occurs if a post-purge time has been programmed. The burner control unit then attempts to restart the burner once. If the burner does not function, a safety shut-down with fault lock-out occurs. The display blinks and shows the fault message.

Parameter O9 = 4: max. 5 × in 15 min. for burner 1. The restart function is active and is also monitored for excessive restarts.

In certain conditions, it is possible that the restart function is repeated continuously without a safety shut-down with subsequent fault lock-out being performed. The BCU has a safety shut-down with subsequent fault lock-out option if more than 5 restarts are performed within a period of 15 minutes.

10.4.2 Minimum operating time t_B

Parameter 61

A minimum operating time (0 to 250 s) may be defined to ensure that the heating equipment operates stably.

If the minimum operating time is active, burner operation will be maintained until the set time has elapsed even if the start-up signal fails.

The minimum operating time starts as soon as the program step for operation/controller enable (display $\square\square$) has been reached.

If the start-up signal drops out before the start of operation/controller enable, e.g. during pre-purge, the burner control unit reverts directly to the start-up position (standby) and the burner is not ignited.

The minimum operating time is cancelled when the BCU is switched off or the mains voltage supply interrupted, or if a safety shut-down occurs.

10.4.3 Pilot burner

Parameter 79

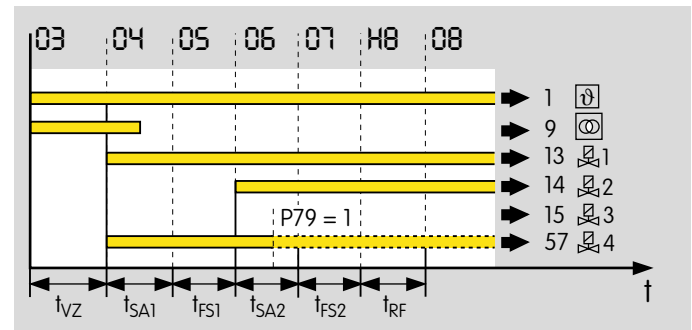

If a burner with a gas pilot is used, this parameter can be used to define whether the gas pilot is shut down 1 second before the end of the second safety time t_{SA2} or operates continuously.

Parameter 79 = 0: with shut-down.

Parameter 79 = 1: in continuous operation.

Taking into account national standards and requirements, it must be clarified whether the gas pilot can remain in operation permanently. Special requirements for the type of burner must be satisfied for this purpose.

10.5 Safety limits

Parameters 10, 12, 13, 15 and 19 can be used to adjust the safety limits (emergency stop, high gas pressure protection, low gas pressure protection, low air pressure protection and safety time during operation) to the system requirements.

10.5.1 Emergency stop

Parameter 10

Function and properties of the controller enable/emergency stop input (terminal 46)

This input is the safety interlock input of the BCU. Activation of this input and the shut-down properties can be set using parameter 10. If the signal is interrupted when the safety interlock input on terminal 46 is active, the BCU initiates a function depending on parameter 10.

Parameter 10 = 0: Off; the function of the safety interlock input is deactivated.

Parameter 10 = 1: On; a safety shut-down will be performed if there is no signal at the controller enable/emergency stop input (terminal 46).

Parameter 10 = 2: On; a fault lock-out will be performed if there is no signal at the controller enable/emergency stop input (terminal 46).

10.5.2 High gas pressure protection

Parameter 12

Function of the gas_{max.} input (terminal 50)

The maximum gas pressure is monitored permanently using the gas_{max.} gas pressure switch connected to terminal 50. Activation of the high gas pressure protection device and the shut-down properties can be set using parameter 12. If the gas pressure exceeds the value set on the gas_{max.} pressure switch, the signal to terminal 50 is interrupted and the BCU initiates a function depending on parameter 12.

Parameter 12 = 0: Off; the high gas pressure protection function is deactivated.

Parameter 12 = 1: On; a safety shut-down will be performed if there is no signal at the gas_{max.} input (terminal 50).

Parameter 12 = 2: On; a fault lock-out will be performed if there is no signal at the gas_{max.} input (terminal 50).

10.5.3 Low gas pressure protection

Parameter 13

Function of the gas_{min} input (terminal 49)

The minimum admissible gas pressure is ensured by the gas_{min} gas pressure switch connected to terminal 49 when the start-up signal ϑ (terminal 1) is applied. Activation of the low gas pressure protection device and the shut-down properties can be set using parameter 13. If the gas pressure falls below the value set on the gas_{min} pressure switch, the signal to terminal 49 is interrupted and the BCU initiates a function depending on parameter 13.

Parameter 13 = 0: Off; the low gas pressure protection function is deactivated.

Parameter 13 = 1: On; a safety shut-down will be performed if there is no signal at the gas_{min} input (terminal 49).

Parameter 13 = 2: On; a fault lock-out will be performed if there is no signal at the gas_{min} input (terminal 49).

10.5.4 Low air pressure protection

Parameter 15

The minimum air pressure is ensured using the air_{min} air pressure switch connected to terminal 47 while the combustion air supply (terminal 58) is switched on. Activation of the low air pressure protection device and the shut-down properties can be set using parameter 15.

If the air pressure falls below the value set on the air_{min} air pressure switch, the signal to terminal 47 is interrupted and the BCU initiates a function depending on parameter 15.

When the combustion air supply (terminal 58) is switched off, the “no flow” state (default position) of the air pressure switch (PZL) is checked. In systems where the combustion air supply is not controlled by the BCU, the air supply to the pressure switch can be interrupted by a 2/3-way valve. The 2/3-way valve is actuated by terminal 58.

Parameter 15 = 0: Off; the low air pressure protection function is deactivated.

Parameter 15 = 1: with safety shut-down. A safety shut-down will be performed if there is no signal at the air_{min} input (terminal 47).

Parameter 15 = 2: with fault lock-out. A fault lock-out will be performed if there is no signal at the air_{min} input (terminal 47).

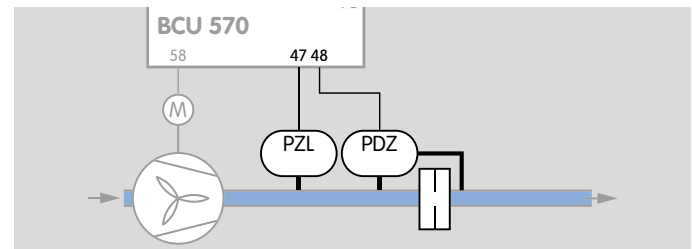

If air flow monitoring is active ($P35 = 1$ or 2), the “no flow” state of the air flow monitoring pressure switch (PDZ) is also checked.

For further information on the low air pressure protection function (air_{min.}, terminal 47, and air flow, terminal 48) during pre-purge, see page 67 (Air flow monitoring during pre-purge).

10.5.5 Safety time during operation t_{SB}

Parameter 19

Parameter 19 = 1; 2: time in seconds

The safety time during operation is the time that the BCU needs to stop the fuel supply after a flame failure during operation or an interruption at the safety limit inputs (terminals 45 to 51 and 65 to 68). The safety time can be set to 1 or 2 s. Prolonging the safety time during operation increases the tolerance with respect to brief-duration signal fades (e.g. fades of the flame signal).

In accordance with EN 298, the maximum reaction time to a flame failure must not exceed 1 s unless specific application standards allow other values.

In accordance with EN 746-2, the safety time of the installation during operation (total closing time) must not exceed 3 s unless specific application standards allow other values.

The requirements of national standards and regulations must be satisfied.

10.6 Air control

10.6.1 Fan run-up time t_{GV}

Parameter 30

This parameter defines the time between the activation of the fan (terminal 58) and the start of the BCU program sequence (display $\square!$).

The fan run-up time can be parameterized in a range between 0 and 6000 s.

10.6.2 Air monitoring during controlled air flow

Parameter 32

Controlled air flow is activated by actuating the input (terminal 2). The connected fan (terminal 58) is switched on. Parameter 32 can be used to adjust the behaviour of the actuator during controlled air flow. It also decides whether the low air pressure protection device (PZL) and the air flow (PDZ) should be monitored during controlled air flow.

Parameter 32 = 0: Off; maximum capacity.

The actuator is moved to the position for maximum capacity during controlled air flow. Monitoring of the low air pressure protection device (PZL) and the air flow (PDZ) is not active.

Parameter 32 = 1: On; maximum capacity.



The actuator is moved to the position for maximum capacity during controlled air flow. Monitoring of the low air pressure protection device (PZL) and the air flow (PDZ) is active. The display on the BCU shows P_I (Pre-purge). The controlled air flow time is subtracted from the pre-purge time of a subsequent burner start.

Parameter 32 = 2: Off; controller enable.

The controller enable signal (terminal 56) is issued during controlled air flow. The position of the actuator can be changed using an external temperature controller (controlled cooling). Monitoring of the low air pressure protection device (PZL) and the air flow (PDZ) is not active.

10.6.3 Pre-purge time t_{pV}

Parameter 34

A burner start may only occur if it has been ensured that the concentration of inflammable components in all sections of the combustion chamber and the connected areas as well as the flue gas ducts is less than 25% of the lower flammability limit of the fuel gas. A pre-purge is generally performed to ensure compliance with these requirements.

Parameter 34 is used to parameterize the pre-purge time in a range between 0 and 6000 s.

The pre-purge time t_{pV} is to be set on the basis of the relevant application standard (e.g. EN 676, EN 746-2, NFPA 85 or NFPA 86).

If air monitoring has been activated in parameter 15 or 35, the pre-purge time t_{pV} starts as soon as the air flow monitor detects an adequate flow for purging, see page 65 (Low air pressure protection) and page 67 (Air flow monitoring during pre-purge).

10.6.4 Air flow monitoring during pre-purge

Parameter 35

Function of the air flow_{min.} input (terminal 48)

The air flow is monitored during pre-purge by the sensor (differential pressure switch) connected to terminal 48. If the air volume falls below the value set on the sensor, the BCU will perform a safety shut-down or fault lock-out.

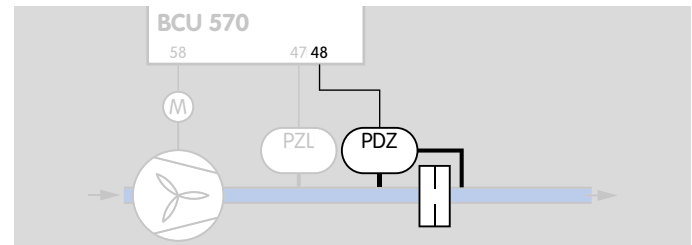

When the fan is switched off, the “no flow” state (default position) of the air flow monitoring sensor is also checked if air flow monitoring has been activated. Activation of air flow monitoring and the shut-down properties can be set using parameter 35.



Parameter 35 = 0: Off; the air flow monitoring function is deactivated.

Parameter 35 = 1: with safety shut-down. If the air flow monitor (terminal 48) trips, a safety shut-down will be performed.

Parameter 35 = 2: with fault lock-out. If there is no signal at the input (terminal 48), a fault lock-out will be performed.

Air flow monitoring is to be set on the basis of the relevant application standard (e.g. EN 676, EN 746-2, NFPA 85 or NFPA 86).

10.6.5 Post-purge time t_{PN}

Parameter 37

If a post-purge time has been set, this will start immediately after the end of the burner operation. This allows the combustion chamber and the flue gas routes to be ventilated to remove fuel gas residues. Parameter 37 is used to parameterize the post-purge time in a range between 0 and 6000 s.

If the post-purge time has been activated, other settings are required for low air pressure protection, see also page 9 (Modulating-controlled forced draught burner with gas pilot and valve proving system).

10.6.6 Air flow monitoring during post-purge

Parameter 38

Parameter 38 is used to define whether the air flow is monitored and which position the actuator assumes during post-purge. Air flow monitoring can only be selected if low air pressure protection (parameter 15 = 1, 2) is active.

Parameter 38 = 0: On; control element to maximum capacity. The actuator is moved to the position for maximum capacity during the post-purge time. The air flow is monitored.

Parameter 38 = 1: Off; control element to maximum capacity. The actuator is moved to the position for maximum capacity during the post-purge time. The air flow is not monitored.

Parameter 38 = 2: Off; control element to ignition capacity. The actuator is moved to the position for ignition capacity during the post-purge time. If the position of the actuator at this time is less than the position for ignition capacity, this position is not changed. The air flow is not monitored.

Parameter 38 = 3: Off; control element controller enable. The controller enable signal (terminal 56) is issued. The position of the actuator can be changed using an external temperature controller (controlled cooling). The air flow is not monitored.

10.6.7 Capacity control

Parameter 40

The BCU is fitted with an interface for connecting air actuators.

The BCU..F1/F2 activates a control element via the outputs for capacity control (terminals 53 to 56) for purging, cooling or starting the burner. This control element moves to the required position for the relevant operating situation.

Using parameter 40, you can set which actuator is used for capacity control (actuators IC 20, IC 40 or RBW).

Parameter 40 = 0: Off; no capacity control (no air actuator).

Parameter 40 = 1: with IC 20.

The interface is configured to the requirements of actuators IC 20, IC 20..E, IC 50 or IC 50..E.

Alternatively, comparable three-point step actuators may be used.



IC 20

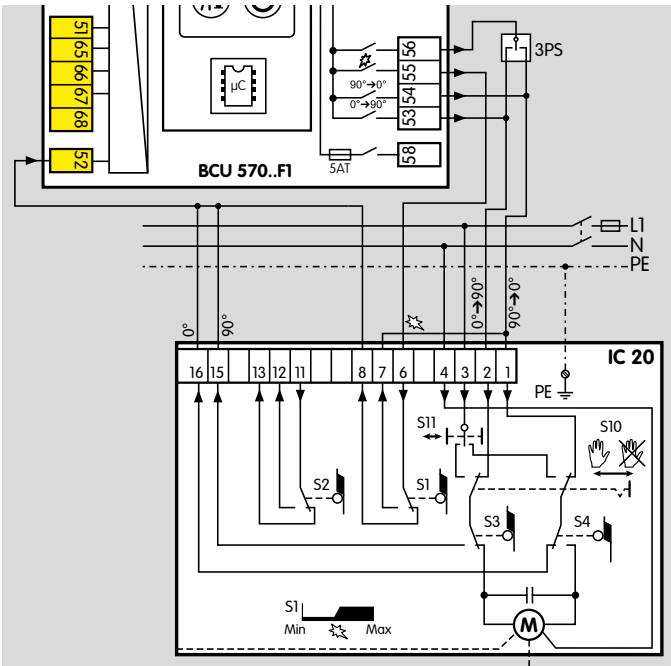

The positions for maximum capacity, ignition capacity and minimum capacity can be set using the actuator. It is checked whether the relevant position has been reached using terminal 52. If the position is not reached within the timeout time of 255 s, the BCU will display fault message F_C , F_D or F_i (maximum, ignition or minimum capacity not reached), see page 46 (Fault signalling).

In the event of a safety shut-down or fault lock-out of the burner control unit, the actuator is moved to the position set via cam S4 for minimum capacity via the output at terminal 54.

Control range between the positions for minimum and maximum capacity

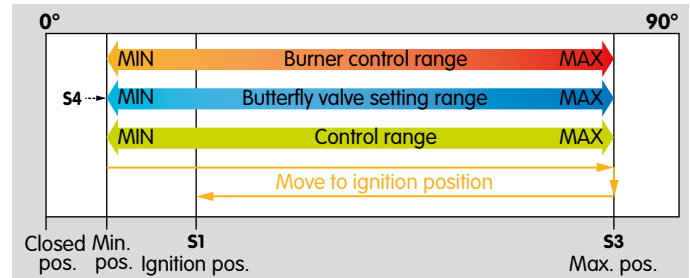

The control system is enabled for operation via the controller enable output (terminal 56). During the controller enable procedure, the actuator can be adjusted infinitely between the positions for maximum and minimum capacity by an external three-point step controller or using bus signals. There is no timeout active in this case.

Control range between the positions for ignition and maximum capacity

The wiring of the 3-point step controller can be adjusted so that the control range of the actuator is between the positions for maximum and ignition capacity.



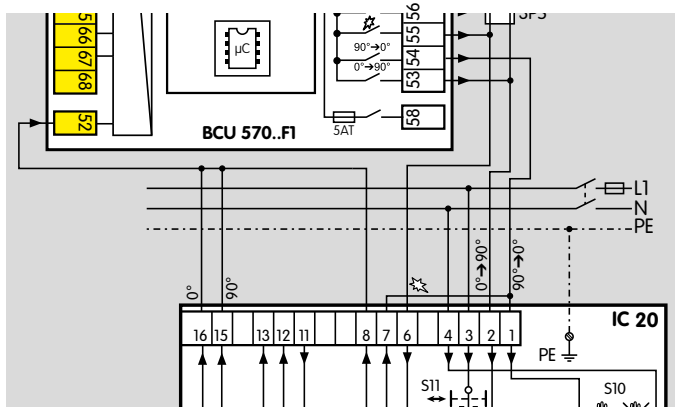

In this case, the minimum position which can be reached is the closed position.

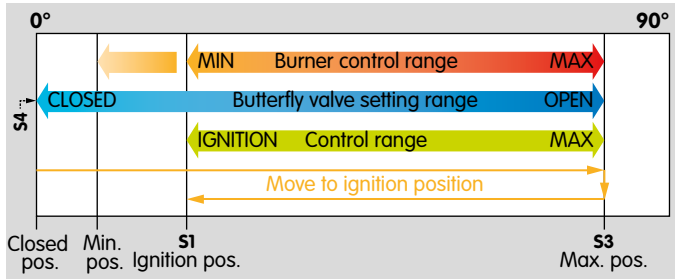

Manual mode

The actuator can be moved in Manual mode. No time-out is active when approaching the required positions. The controller enable output (terminal 56) is not active and not checked.

IC 20..E

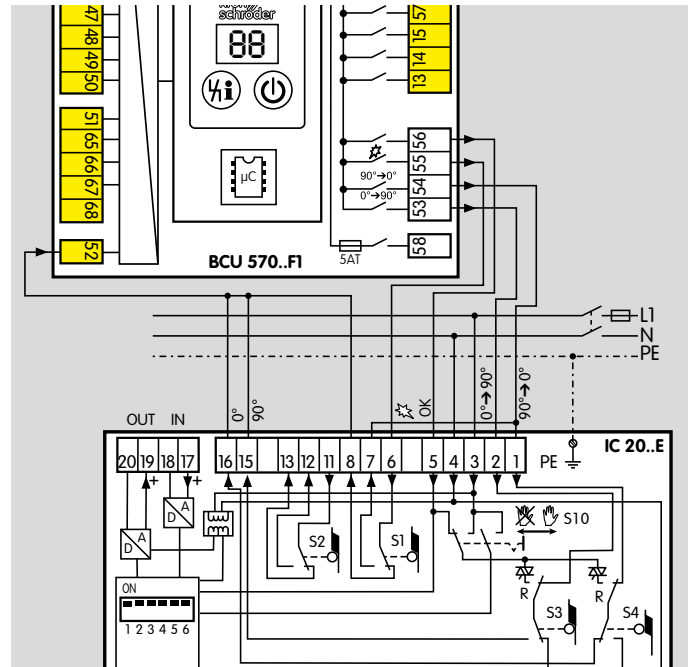

The positions for minimum capacity, maximum capacity and ignition capacity can be set using the actuator. When the appropriate position has been reached, this information is signalled back to terminal 52.

If the position is not reached within the timeout time of 255 s, the BCU will display fault message *Rc*, *Ra* or *R* (maximum, ignition or minimum capacity not reached), see page 46 (Fault signalling).

Control range between the positions for minimum and maximum capacity

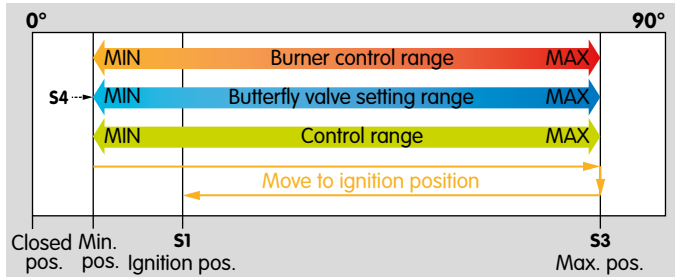

The control system is enabled during operation via the controller enable output (terminal 56). During the controller enable procedure, the actuator can be adjusted infinitely between the positions for maximum and minimum capacity using its analogue input (terminals 17 and 18). There is no timeout active in this case.

Manual mode

The actuator can be moved in Manual mode. No timeout is active when approaching the required positions. The controller enable output (terminal 56) is not active and not checked.

IC 40

Parameter 40 = 2: with IC 40.

To ensure that the actuator IC 40 can be operated on the BCU..F1, P40 = 2 (capacity control) must be set. The operating mode of control element IC 40 must be parameterized to 27.

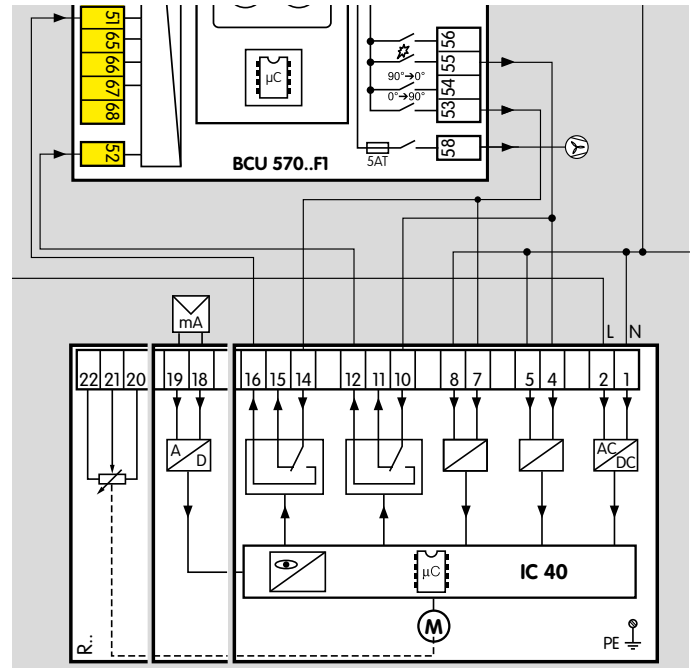

The positions for maximum capacity and ignition capacity can be set using the actuator.



Parameter

Terminal 51 checks whether the position for maximum capacity has been reached. Terminal 52 checks the position for ignition capacity. If the position is not reached within the timeout time of 255 s, the BCU will display fault message R_C , R_D or R (maximum, ignition or minimum capacity not reached), see page 46 (Fault signalling).

Controller enable is issued by activating the outputs at terminals 53 and 55).

During the controller enable procedure, the actuator IC 40 can be adjusted infinitely between the positions for maximum and minimum capacity using its analogue input (terminals 18 and 19). There is no timeout active in this case.

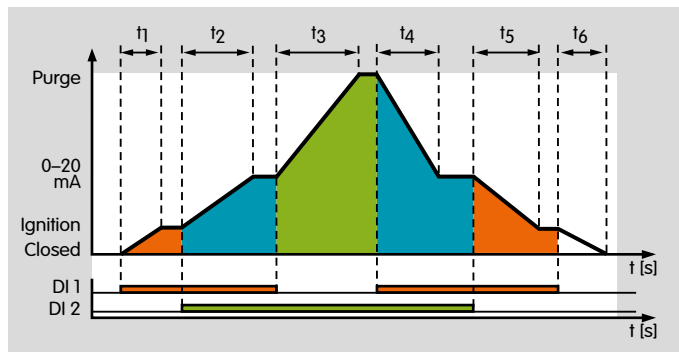

BCU		IC 40	
Signal at terminal		Position	Butterfly valve position
55	53		
OFF	OFF	Closed	Closed
ON	OFF	Ignition	Minimum/Ignition capacity
ON	ON	0 – 20 mA	Any position between minimum and maximum capacity
OFF	ON	Purge	Maximum capacity

In the event of a fault and in standby, there will be no signal at terminals 53 and 55 so that the actuator moves to the closed position. When approaching the closed position, no timeout of 255 s is active since no feedback input is checked. This may result in a situation where the program is continued in the case of a request for the closed position, without the butterfly valve being closed. The outputs at terminals 56 (controller enable) and 54 (closed position) on the BCU are non-functional and are not activated.

Manual mode

In Manual mode, no external controller is enabled. The actuator can be moved to the positions for maximum capacity or ignition capacity by the user. No timeout is active when approaching the required positions.

RBW

Parameter 40 = 3: with RBW.

The actuator can be moved to the positions for maximum capacity (contact COM to HI) and minimum capacity (contact COM to LO) using the interface and by closing the various contacts.

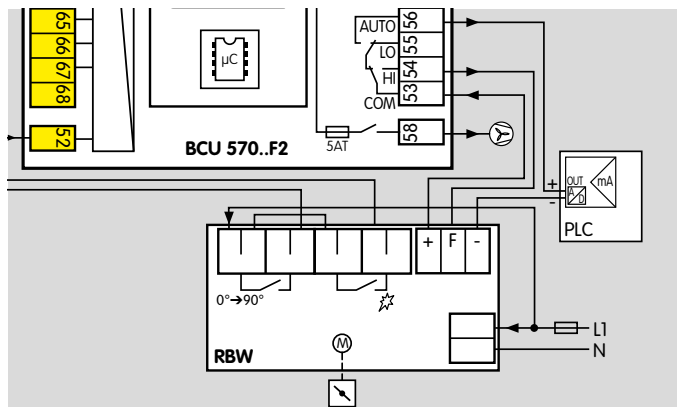
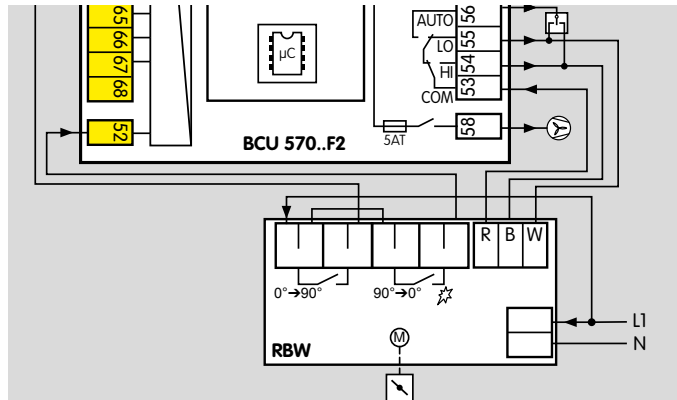

The RBW actuator reports that it has reached the position for maximum capacity via a signal to terminal 51. The actuator reports that it has reached the position for minimum capacity via a signal to terminal 52. The simultaneous activation of terminals 51 and 52 results in a fault lock-out of the BCU.

If parameter 41 = 0, the system monitors the movement to the positions for maximum and minimum capacity with a timeout time of 255 s. Reaching the relevant position immediately triggers the program continue switch conditions. If reaching the position is not signalled within the timeout time of 255 s, a safety shut-down of the BCU will be performed. A fault message (R_C or R_D) will be displayed, see page 46 (Fault signalling).



Parameter

If parameter 41 = 1, the system does not monitor whether the positions for minimum and maximum capacity are reached. In this case, a running time of up to 250 s must be defined using parameter 42, see page 78 (Running time). The program continues when switch conditions are then controlled dependent on this time.

If a fault occurs, the actuator is moved to the position for minimum capacity.

Manual mode

In Manual mode, no external controller is enabled during the controller enable procedure. The actuator can be moved to the positions for maximum capacity or ignition capacity by the user. No timeout is active when approaching the required positions.

Frequency converter

Parameter 40 = 4: with frequency converter.

The interface is configured according to the requirements of a frequency converter for fans.

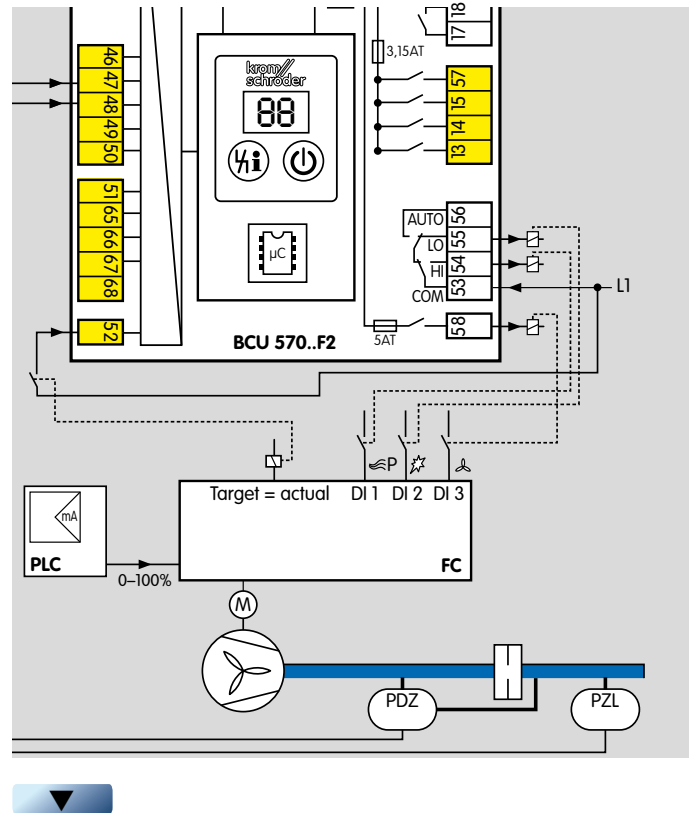

Parameter

The BCU bridges the connections at terminals 53 and 54 (COM – HI bridge) for pre-purge. The frequency converter sets the fan to the speed for maximum capacity. The frequency converter reports that the speed for maximum capacity has been reached by a signal (target = actual) to the BCU via terminal 52.

After the elapse of the pre-purge time, the BCU bridges the connections at terminals 53 and 55 (COM – LO bridge). The frequency converter sets the fan to the speed for minimum capacity (ignition capacity). The frequency converter reports that the speed for minimum capacity (ignition capacity) has been reached by a signal (target = actual) to terminal 52. If the positions are not reached within the timeout time of 255 s, the BCU will display fault message R_c , R_o or R_i (maximum, ignition or minimum capacity not reached), see page 46 (Fault signalling). As soon as the burner operating signal has been received, the BCU bridges the connections at terminals 53 and 56 (COM – AUTO bridge). This disconnects the outputs at terminals 54 and 55 from the voltage supply to issue the controller enable signal to the frequency converter. During the controller enable procedure, the speed of the fan can be adjusted infinitely between minimum and maximum capacity using the analogue input of the frequency converter. There is no timeout active in this case.

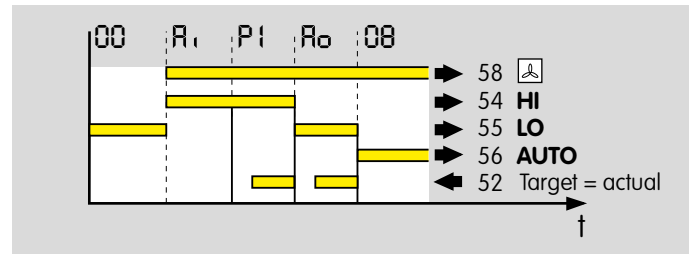

BCU		Frequency converter		
Contact between terminals		Signal to	Position	Fan speed
53	55	DI 2/DI 3	Ignition	Minimum/Ignition capacity
53	56	DI 3	0 – 20 mA	Any speed between minimum and maximum capacity
53	54	DI 1/DI 3	Purge	Maximum capacity

Manual mode

In Manual mode, the frequency converter can be set to the speed for maximum air volume or minimum air volume (pilot air volume). Adjustment by the control system is not possible. No timeout is active when approaching these speeds.

10.6.8 Running time selection

Parameter 41

This parameter can only be set on the BCU 570..F2 version in conjunction with an actuator with an RBW interface.

Parameter 41 = 0: Off; checking the positions for minimum/maximum capacity. A signal that the positions for minimum and maximum capacity have been reached is returned and monitored with a timeout time of max. 255 s. When the position has been reached, the BCU will initiate the next program step.

Parameter 41 = 1: On; for approaching the positions for minimum/maximum capacity. The Running time set using parameter 42 is activated for approaching these positions. After this time has elapsed, the BCU will initiate the next program step.

Parameter 41 = 2: On; for approaching the position for maximum capacity. The Running time set using parameter 42 is activated for approaching the position for maximum capacity. After this time has elapsed, the BCU will initiate the next program step. Approaching the position for minimum capacity is signalled and monitored.

Parameter 41 = 3: On; for approaching the position for minimum capacity. No signal is returned that the position for minimum capacity has been reached. The Running time set using parameter 42 is activated for approaching the position for minimum capacity. After this time has elapsed, the BCU will initiate the next program step. Approaching the position for maximum capacity is signalled and monitored.

10.6.9 Running time

Parameter 42

Parameter 42 is only active if parameter 40 = 3 and parameter 41 = 1, 2 or 3.

This parameter is used to define the running time of the RBW actuator if it only signals one position or no positions (parameter 41 = 1, 2 or 3).

The program sequence of the burner control unit can be adapted to the closing behaviour of the actuator using this parameter.

The running time must be set such that the actuator can reach the position required for the next program step without any problems.

10.6.10 Low fire over-run

Parameter 43

This parameter can only be set on the BCU 570..F1 version in conjunction with an actuator IC 20 (P40 = 1).

The low fire over-run (t_{KN}) is applicable to systems with a pneumatic air/gas ratio control system and On/Off control. Using the low fire over-run function reduces the O_2 content in the furnace atmosphere. In addition, pressure peaks and thus tripping of safety devices in the event of a shut-down at high-fire rate are prevented.

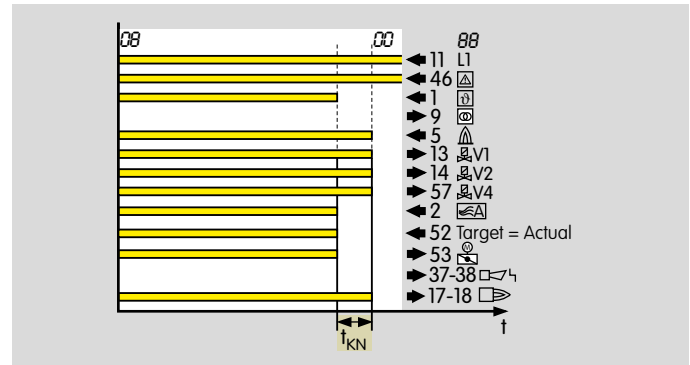

Parameter 43 = 0: Off. No low fire over-run is performed. The gas circuit is closed immediately owing to a quick closing gas valve in the case of On/Off control. Pressure peaks during this process can cause tripping of safety devices. The air circuit is closed more slowly. The air flowing in during this time increases the O_2 content in the combustion chamber.

Parameter 43 = 1 (only for BCU..F1/F2): up to minimum capacity. The burner is not immediately switched off after the start-up signal ϑ (terminal 1) has been removed. During low fire over-run, the control element is moved to the position for minimum capacity and the gas valves remain open until the flame fails or the position for minimum capacity is reached. If the flame is extinguished, this does not result in a fault.

10.6.11 Controller enable signal delay time t_{RF}

Parameter 44

The controller enable signal is delayed by 0, 10, 20 or 30 up to 250 s using parameter 44.

If the BCU has successfully started the burner, after the elapse of the safety time and the flame proving period, if parameterized, the controller enable signal to the external temperature controller is delayed. The BCU shows program status *HB*. After the elapse of the delay time t_{RF} , the burner operation signalling contact (terminals 17, 18) is closed and the controller enable output (terminal 56) activated. The display changes to *00*.

10.6.12 Capacity control (bus)

Parameter 75

Controlling the burner capacity using the fieldbus is only possible with bus module BCM 500 connected and enabled (P80 = 1 or 2).

Output terminal 56 is no longer available for controller enable if bus control is active.

Parameter 75 = 0: Off. No capacity control possible using the fieldbus.

Parameter 75 = 1: MIN. to MAX. capacity; standby in position for MIN. capacity. The control range while the burner is operating is between the positions for minimum capacity (S4) and maximum capacity (S3). The burner is ignited in the position for ignition capacity (S1). When the burner is switched off, the actuator is moved to the position for minimum capacity (S4).

This operating mode can be achieved with an actuator IC 20, RBW or alternatively with a comparable three-point step actuator.

If the air supply is stopped on a heated furnace with the burner switched off, the controls may be damaged by the hot furnace atmosphere as a result of the lowest possible position of the butterfly valve, limited by S4.

IC 20

Switching cam setting for ignition capacity, minimum and maximum capacity as well as pre-purge and standby:

S1: for ignition capacity of the burner.

S3: for maximum capacity of the burner and pre-purge.

S4: for minimum capacity of the burner and standby.

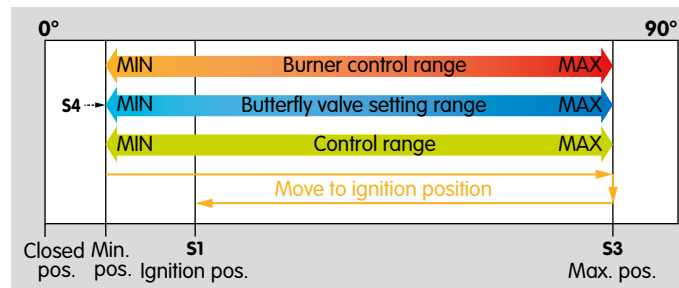

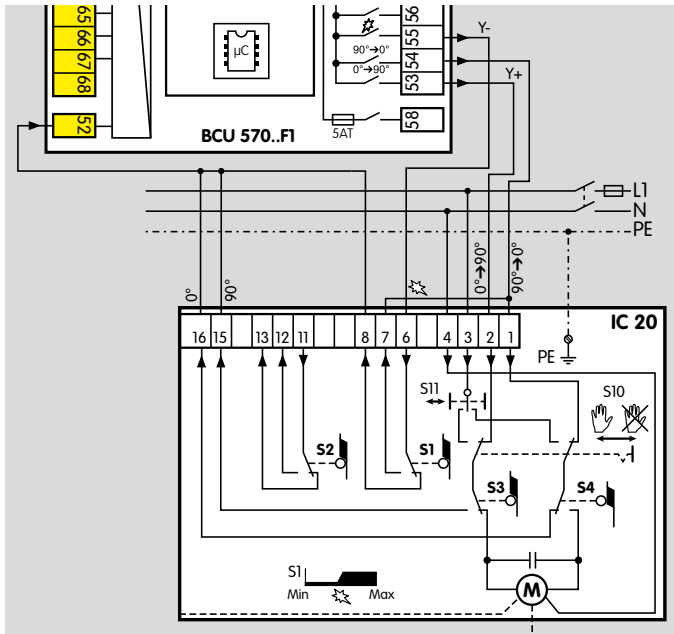

If the air supply is stopped on a heated furnace with the burner switched off, the controls are protected from the hot furnace atmosphere as a result of the butterfly valve being in the closed position (limited by S4). Check whether the burner can cope without cooling in this situation.



Parameter 75 = 2: MIN. to MAX. capacity; standby in CLOSED position. The control range while the burner is operating is between the positions for minimum capacity (S2) and maximum capacity (S3). The burner is ignited in the position for ignition capacity (S1). When the burner is switched off, the actuator is moved to the closed position (S4).

This operating mode can be achieved with an actuator IC 20 or alternatively with a comparable three-point step actuator.

IC 20

Switching cam setting for ignition capacity, minimum and maximum capacity as well as pre-purge and standby:

- S1: for ignition capacity of the burner.
- S2: for minimum capacity of the burner.
- S3: for maximum capacity of the burner and pre-purge.
- S4: for the closed position of the butterfly valve and standby.

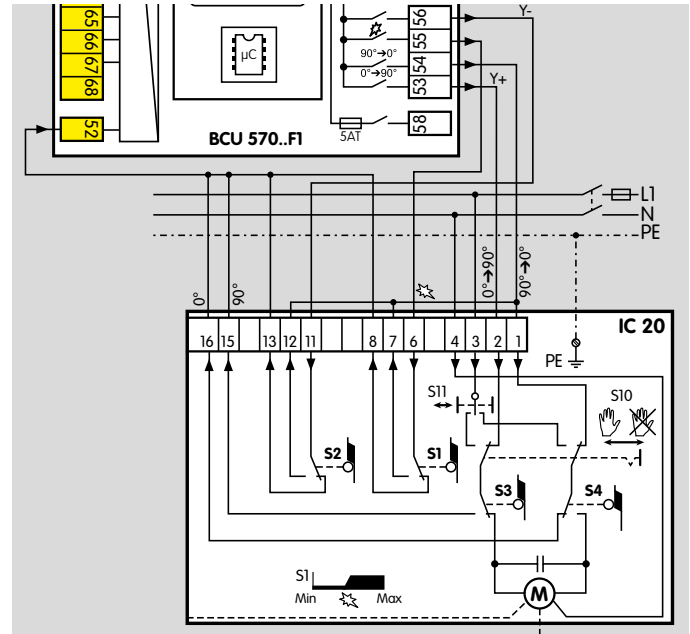
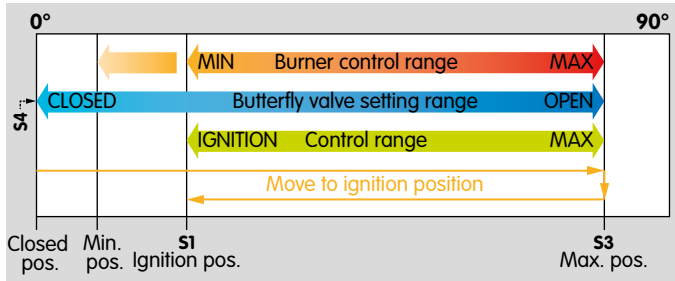

Parameter 75 = 3: IGNITION to MAX. capacity; standby in CLOSED position.

The control range while the burner is operating is between the positions for minimum capacity (S1) and maximum capacity (S3). The burner is ignited in the position for minimum capacity (S1). When the burner is switched off, the actuator is moved to the closed position (S4).

This operating mode can be achieved with an actuator IC 20 or alternatively with a comparable three-point step actuator. 

Parameter

If the air supply is stopped on a heated furnace with the burner switched off, the controls are protected from the hot furnace atmosphere as a result of the butterfly valve being in the closed position (limited by S4). Check whether the burner can cope without cooling in this situation.

IC 20

Switching cam setting for ignition capacity, minimum and maximum capacity as well as pre-purge and standby:

S1: for minimum capacity and ignition capacity of the burner.

S3: for maximum capacity of the burner and pre-purge.

S4: for the closed position of the butterfly valve and standby.

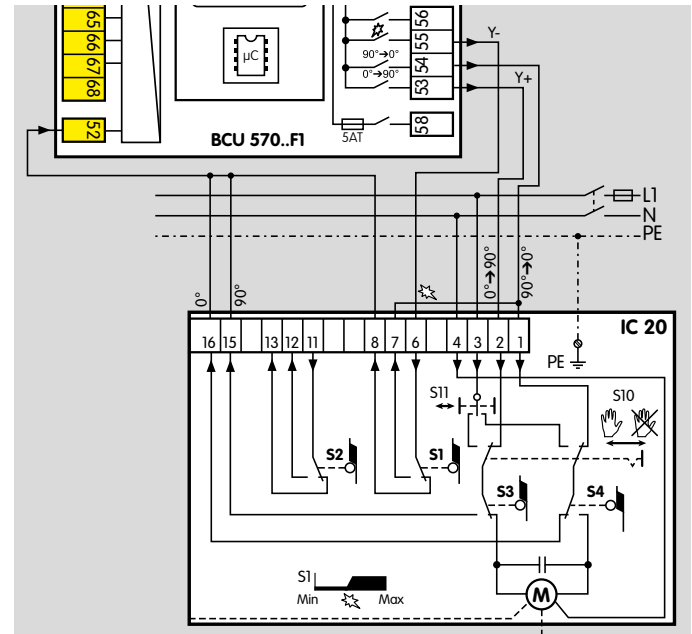
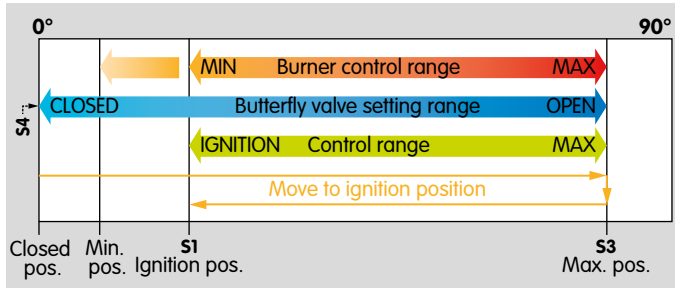

Parameter 75 = 4: MIN. to MAX. capacity; standby in position for MIN. capacity; burner quick start.

The control range while the burner is operating is between the positions for minimum capacity (S4) and maximum capacity (S3). The burner is ignited in the position for ignition capacity (S1). Switching cam S2 (reverse direction of rotation) ensures that the position for ignition capacity is approached without pre-purging first (quick start). When the burner is switched off, the actuator is moved to the position for minimum capacity (S4).

Parameter

This operating mode can be achieved with an actuator IC 20 or alternatively with a comparable three-point step actuator.

If the air supply is stopped on a heated furnace with the burner switched off, the controls may be damaged by the hot furnace atmosphere as a result of the lowest possible position of the butterfly valve, limited by S4. If pre-purge is active, considerably lower air capacity than the maximum air capacity will be used for purging.

IC 20

Switching cam setting for ignition capacity, minimum and maximum capacity and reverse direction of rotation to approach the position for ignition capacity:

- S1: for ignition capacity of the burner.
- S2: for reversing the direction of rotation to approach the position for ignition capacity.
- S3: for maximum capacity of the burner and pre-purge.
- S4: for the closed position of the butterfly valve and standby.

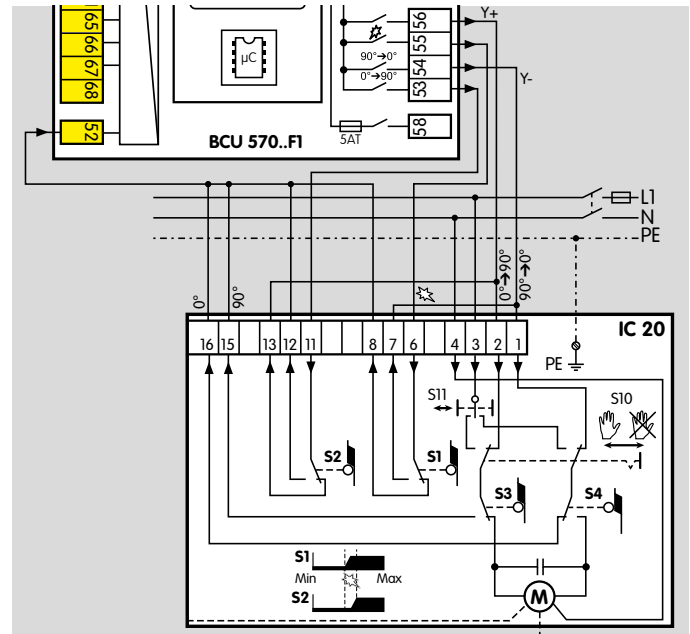
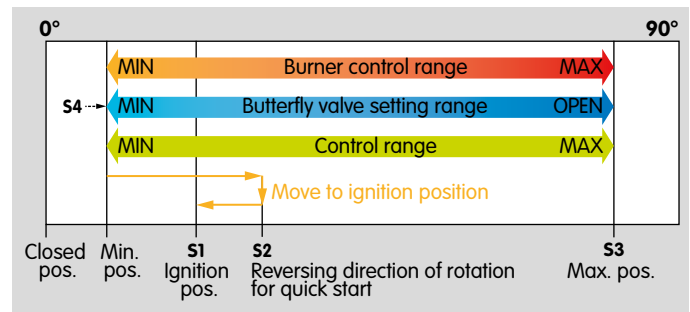

Parameter 75 = 5: IGNITION to MAX. capacity; standby in CLOSED position; burner quick start.

The control range while the burner is operating is between the positions for ignition capacity (S1) and maximum capacity (S3). The burner is ignited in the position for ignition capacity (S1). Switching cam S2 (reverse direction of rotation) ensures that the position for ignition capacity is approached without pre-purging first (quick start). When the burner is switched off, the actuator is moved to the closed position (S4).

This operating mode can be achieved with an actuator IC 20 or alternatively with a comparable three-point step actuator.

If the air supply is stopped on a heated furnace with the burner switched off, the controls are protected from the hot furnace atmosphere as a result of the butterfly valve being in the closed position (limited by S4). Check whether the burner can cope without cooling. If pre-purge is active, considerably lower air capacity than the maximum air capacity will be used for purging.



IC 20

The position for maximum capacity is achieved by the controller enable output (terminal 56).

Switching cam settings S1, S2, S3 and S4:

- S1: for minimum capacity and ignition capacity of the burner.
- S2: for reversing the direction of rotation to approach the position for ignition capacity. The actuator will move to the position for ignition capacity without reaching the position for maximum burner capacity.
- S3: for maximum capacity of the burner and pre-purge.
- S4: for the closed position of the butterfly valve and standby.

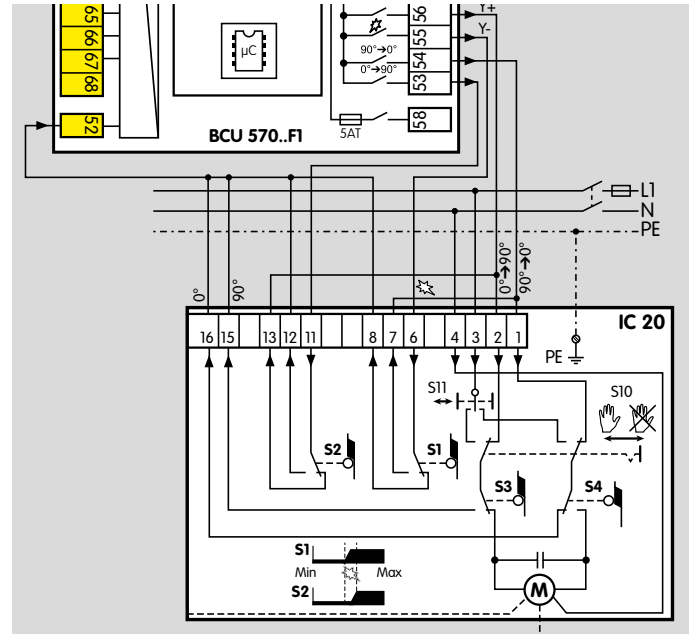
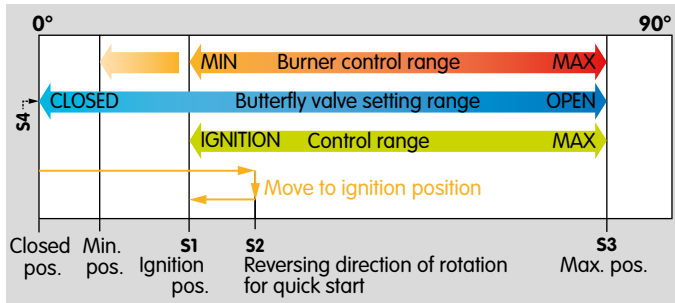

10.7 Valve check

10.7.1 Valve proving system

Parameter 51

Parameter 51 is used to define whether and at what time in the BCU program sequence the valve check is activated. This allows either the tightness of the gas solenoid valves and the pipework between them to be checked (tightness test) or the closed position of a solenoid valve (proof of closure function) to be checked. If the proof of closure function is activated, the closed position of the gas solenoid valve on the inlet side is checked using a POC switch.

Parameter 51 = 0: Off. No valve check is activated.

Parameter 51 = 1: tightness test before start-up.

Parameter 51 = 2: tightness test after shut-down. With this setting, a tightness test is also performed after a fault is reset and after mains on.

Parameter 51 = 3: tightness test before start-up and after shut-down.

An additional bypass valve must be installed in gas sections with an air/gas ratio control. This valve allows the closed air/gas ratio control to be bypassed during the tightness test.

Parameter 51 = 4: proof of closure function (POC).

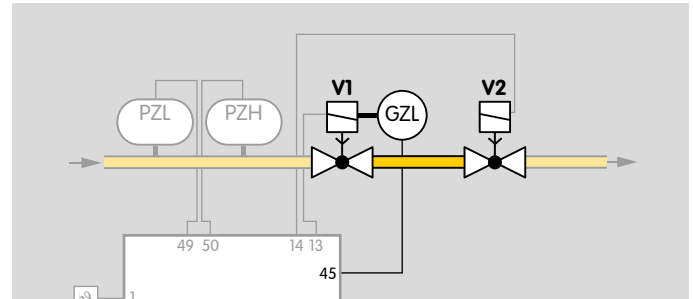

A signal is sent to the BCU via the POC switch on the gas solenoid valve on the inlet side before burner start-up stating that the valve is closed. After burner start-up, the signal must drop out to indicate to the BCU that the valve is open.

10.7.2 Relief valve (VPS)

Parameter 52

A valve connected to terminal 14, 15 or 57 can be selected to act as a relief valve during a tightness test.

Parameter 52 = 2: V2. The valve on terminal 14 acts as the relief valve.

Parameter 52 = 3: V3. The valve on terminal 15 acts as the relief valve.

Parameter 52 = 4: V4. The valve on terminal 57 acts as the relief valve.

10.7.3 Measurement time V_{p1}

Parameter 56

The required measurement time must be determined according to the requirements of the appropriate application standards, e.g. EN 1643.

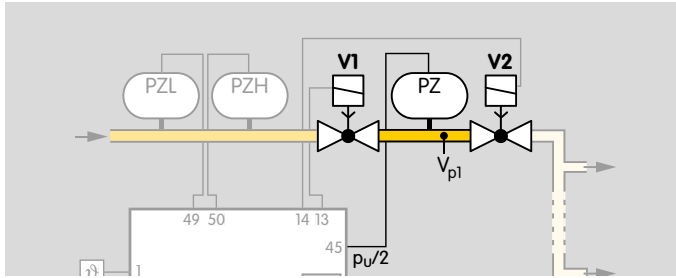

The required measurement time for the tightness test of V_{p1} can be set using parameter 56. The possible settings are 3 s, 5 to 25 s (in 5 s steps) or 30 to 3600 s (in 10 s steps).

See also page 31 (Measurement time t_M).

10.7.4 Valve opening time t_{L1}

Parameter 59

This parameter is used to define the opening time for the valves (2 to 25 s) which are opened to fill or discharge the test volume between the gas valves.

If the preset opening time $t_L = 2$ s is inadequate (e.g. if slow opening valves are used) to fill the test volume or reduce the pressure between the valves, bypass valves can be used instead of the main valves.

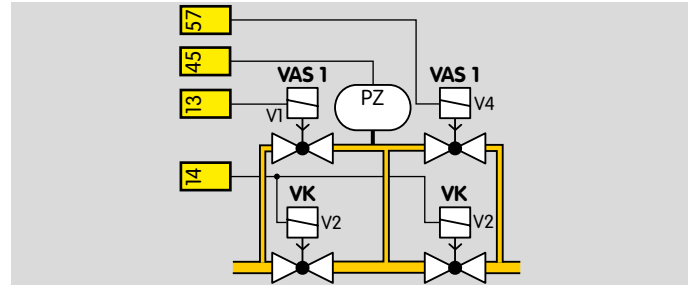

On condition that the gas volume which flows into the combustion chamber is no larger than 0.083% of the maximum flow rate, the opening time of the bypass valves may be longer than the 3 s permitted by the standard (EN 1643:2000). The required volume limit can be achieved by fitting a restrictor or orifice, for example. The opening time to be set is then calculated on the basis of this restrictor or orifice.

Calculating the opening time, see page 30 (Calculating the extended opening time).

10.8 Behaviour during start-up

10.8.1 Minimum pause time t_{MP}

Parameter 62

A minimum pause time t_{MP} (0 to 3600 s) can be defined to achieve stable operation of the burners. If the post-ventilation time set using parameter 39 has elapsed and no signal (\ominus) is received at terminal 1 (burner shut down), a restart and controlled air flow are prevented for the duration of the minimum pause time t_{MP} .

If a signal is applied to terminal 1 (burner start-up) or terminal 2 (controlled air flow) during the minimum pause time, status display Delay  will appear.

10.8.2 Switch-on delay time t_E

Parameter 63

Defines the time between applying the start-up signal (start or controlled air flow) and initiating the fan run-up time (0 to 25 s).

When several BCUs are activated simultaneously, setting different switch-on delay times t_E prevents the fans from starting at the same time and reduces the load on the power supply.

The switch-on delay also applies to the TC function. It is also active if the unit is switched on and the start-up signal was already present. If the switch-on delay is active, status display  will appear. The switch-on delay can be set in the range from 0 to 250 s.

10.9 Manual mode

If the Reset/Information button is pressed for 2 s during switch-on, the BCU reverts to Manual mode. Two dots blink on the display. The BCU is now operating in Manual mode independently of the status of the inputs of the start-up signal (terminal 1), controlled air flow (terminal 2) and remote reset (terminal 3). The functions of the safety-relevant inputs/controller enable/emergency stop (terminal 46) are retained. The manual start-up of the BCU can be initiated in Manual mode by pressing the Reset/Information button. Each time the button is pressed again, the BCU moves to the next step of the program sequence and stops there, for example for adjusting an actuator or the gas/air mixture.

Actuator IC 20, IC 40, RBW and frequency converter

Following controller enable (status display \overline{BB}), a connected actuator can be opened and closed as required. By holding the button, the actuator is first opened further. The BCU indicates $\overline{R0}$ with blinking dots. Once the button has been released, the actuator stops in the relevant position. Pressing it again will result in closing the actuator to the position for minimum capacity. The BCU indicates \overline{RE} with blinking dots.

A change of direction takes place each time the button is released and pressed again. When the actuator has reached its final position, the dots disappear.

10.9.1 Operating time in Manual mode

Parameter 67

Parameter 67 determines when Manual mode is terminated.

Parameter 67 = 0: Manual mode is not limited in time. If this function has been selected, operation of the burner may be continued manually in the event of failure of the control system or the bus activation.

Parameter 67 = 1: the BCU will terminate Manual mode 5 minutes after the last time the button is pressed. It then moves abruptly back to the start-up position (standby).

If the unit is switched off or a power failure occurs, Manual mode on the BCU will be terminated regardless of parameter 67.

10.10 Functions of terminals 51, 65, 66, 67 and 68

Terminals 51, 65, 66, 67 and 68 can each be assigned a logical AND gating with one of the inputs for the safety functions (terminals 46 – 50) using an appropriate parameter. If AND gating is not required, the input concerned can be disabled.

Terminal 51 can also be used as a feedback input for the maximum capacity position when operated with IC 40/RBW.

10.10.1 Function of terminal 51

Parameter 69

Parameter 69 = 0: Off

Parameter 69 = 8: AND with input at terminal 46 (emergency stop)

Parameter 69 = 9: AND with input at terminal 47 (air_{min.} pressure switch)

Parameter 69 = 10: AND with input at terminal 48 (air flow pressure switch)

Parameter 69 = 11: AND with input at terminal 49 (gas_{max.} pressure switch)

Parameter 69 = 12: AND with input at terminal 50 (gas_{min.} pressure switch)

Parameter 69 = 13: max. capacity position feedback (IC 40/RBW), see page 74 (RBW).

10.10.2 Function of terminal 65

Parameter 70

Parameter 70 = 0: Off

Parameter 70 = 8: AND with input at terminal 46 (emergency stop)

Parameter 70 = 9: AND with input at terminal 47 (air_{min.} pressure switch)

Parameter 70 = 10: AND with input at terminal 48 (air flow pressure switch)

Parameter 70 = 11: AND with input at terminal 49 (gas_{max.} pressure switch)

Parameter 70 = 12: AND with input at terminal 50 (gas_{min.} pressure switch)

10.10.3 Function of terminal 66

Parameter 71

Parameter 71 = 0: Off

Parameter 71 = 8: AND with input at terminal 46 (emergency stop)

Parameter 71 = 9: AND with input at terminal 47 (air_{min.} pressure switch)

Parameter 71 = 10: AND with input at terminal 48 (air flow pressure switch)

Parameter 71 = 11: AND with input at terminal 49 (gas_{max.} pressure switch)

Parameter 71 = 12: AND with input at terminal 50 (gas_{min.} pressure switch)

10.10.4 Function of terminal 67

Parameter 72

Parameter 72 = 0: Off

Parameter 72 = 8: AND with input at terminal 46 (emergency stop)

Parameter 72 = 9: AND with input at terminal 47 (air_{min.} pressure switch)

Parameter 72 = 10: AND with input at terminal 48 (air flow pressure switch)

Parameter 72 = 11: AND with input at terminal 49 (gas_{max.} pressure switch)

Parameter 72 = 12: AND with input at terminal 50 (gas_{min.} pressure switch)

10.10.5 Function of terminal 68

Parameter 73

Parameter 73 = 0: Off

Parameter 73 = 8: AND with input at terminal 46 (emergency stop)

Parameter 73 = 9: AND with input at terminal 47 (air_{min.} pressure switch)

Parameter 73 = 10: AND with input at terminal 48 (air flow pressure switch)

Parameter 73 = 11: AND with input at terminal 49 (gas_{max.} pressure switch)

Parameter 73 = 12: AND with input at terminal 50 (gas_{min.} pressure switch)

10.11 Password

Parameter 77

The password is designed to protect the parameter settings. To prevent unauthorized changes to parameter settings, a password is stored in parameter 77 (0000 to 9999). Changes to parameter settings can only be made once this number has been entered. The password can be changed using BCSOft. Note the effect of parameter settings on the safe functioning of your system.

10.12 Fieldbus communication

Parameter 80

Fieldbus communication can be activated using parameter 80 when bus module BCM 500 is connected.

A device name must be entered in the automation system for the unique identification of the control unit (BCU/FCU) in the Profinet IO system.

Parameter 80 = 0: Off. Parameterization access using BCSOft via Ethernet is still possible.

Parameter 80 = 1: with address check. The device name on delivery is “not-assigned-bcu-570-xxx”. The expression “not-assigned-” must be deleted or may be replaced with an individual name.

The sequence xxx must be identical to the address set on the BCM 500 using the code switches (xxx = address in the range 001 to FEF).



Parameter 80 = 2: no address check. The device name can be selected as specified by the automation system.

11 Selection

	Q	W	C0	C1	F1	F2	U0	K0	K1	K2	E
BCU 570	●	●	●	○	●	○	○	○	●	○	●

● = standard, ○ = available

Order example

BCU 570WC1F1U0K1E

11.1 Type code

Code	Description
BCU	Burner control unit
570	Series 570
Q	Mains voltage: 120 V AC, 50/60 Hz
W	230 V AC, 50/60 Hz
C0	No valve proving system
C1	With valve proving system
F1	Capacity control: modulating with IC interface
F2	modulating with RBW interface
U0	Ionization or UV control in case of operation with gas
K0	No connection plug
K1	Connection plug with screw terminals
K2	Connection plug with spring force terminals
E	Individual packaging

12 Project planning information

12.1 Installation

Installation position as required.

The BCU mounting is designed for horizontally aligned 35 × 7.5 mm DIN rails.

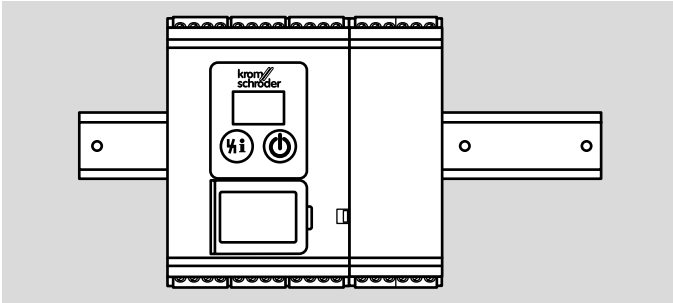

If the DIN rail is aligned vertically, end clamps are required (e.g. Clipfix 35 by Phoenix Contact) to prevent the BCU from slipping.

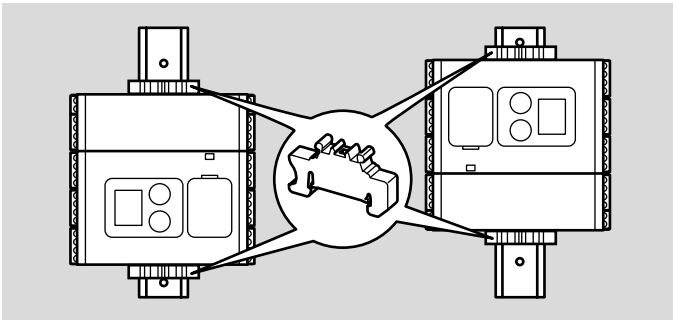

Environment

Install in a clean environment (e.g. a control cabinet) with an enclosure \geq IP 54, whereby no condensation is permitted.

12.2 Commissioning

Do not start the BCU until the parameter settings and wiring are correct and the faultless processing of all input and output signals complies with the local standards.

12.3 Electrical connection

The BCU is designed for connection to a 1-phase system. All inputs and outputs have a one-phase mains supply. Other connected burner control units must use the same phase of the mains supply.

Signal and control line for screw terminals max. 2.5 mm² (AWG 12), for spring force terminals max. 1.5 mm² (AWG 16).

Do not route BCU cables in the same cable duct as frequency converter cables or cables emitting strong fields.

External electrical interference must be avoided.

For information on the type of network, see page 106 (Technical data).

12.3.1 OCU

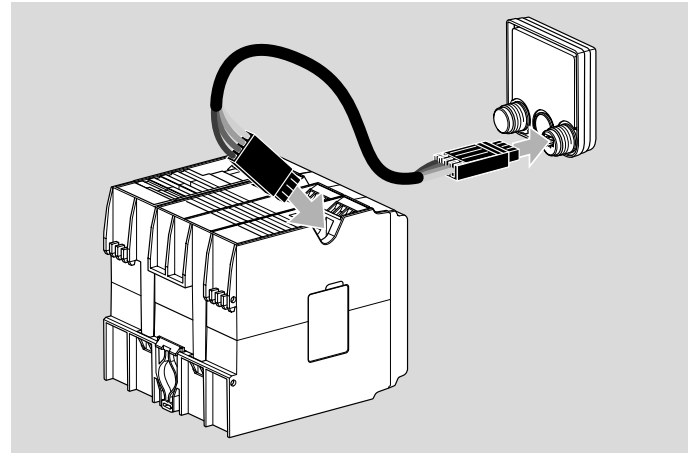

Cables for signalling and telecommunications systems are recommended for wiring the supplied plug connectors:

Cable length max. 10 m, 4-pin,
min. 0.25 mm² (AWG 24),
max. 0.34 mm² (AWG 22).

12.3.2 Safety current inputs

Actuation of the safety current inputs only with switch-gear featuring mechanical contacts. If switchgear with semi-conductor contacts is used, the safety current inputs must be connected using relay contacts.

To safeguard the safety current inputs, the fuse must be designed so that the sensor with the lowest switching capacity is protected.

The cabling outside enclosed installation spaces must be protected from mechanical damage and stress (e.g. vibration or bending) as well as short-circuits, short-circuits to ground and cross-circuits.

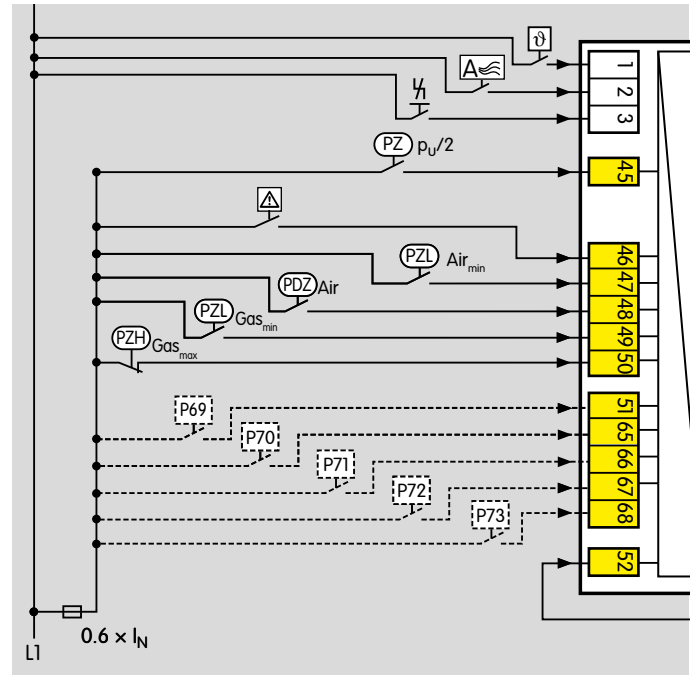

Calculation

I_N = current of the sensor/contactors with the lowest switching capacity

Suitable fuse = $0.6 \times I_N$

12.4 Actuators

If actuators are used, the start gas rate of the burners must be limited for SIL 3 applications in compliance with the standard.

12.4.1 IC 20

The BCU..F1 checks the position to which the actuator IC 20 has moved using terminal 52 (feedback) by lifting the signal to terminal 53, 54 or 55, see page 114 (Lifting).

To ensure this check is possible, BCU..F1 and actuator IC 20 or equivalent three-point step actuators must be wired as shown in the connection diagram.

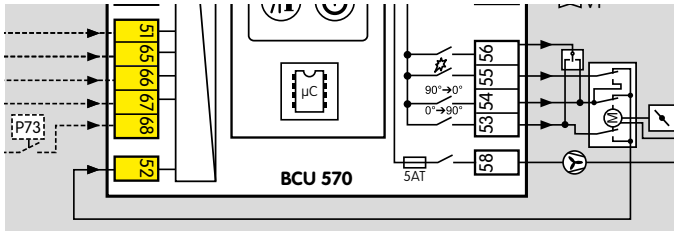

12.5 Air control

Starting the fan with the butterfly valve closed reduces the start-up current of the fan motor.

12.6 Parameter chip card

The parameter chip card must be installed in the unit for the BCU to operate. The parameter chip card contains the valid parameters for the BCU. If a BCU is replaced, the parameter chip card can be removed from the old unit and inserted into the new BCU. The BCU must be disconnected from the electrical power supply for this purpose. The valid parameters are then adopted by the new BCU. The old device and the new BCU must have an identical type code.

13 Accessories

13.1 BCSoft

The current software can be downloaded from our Internet site at www.docuthek.com. To do so, you need to register in the DOCUTHEK.

13.1.1 Opto-adapter PCO 200



Including BCSoft CD-ROM,
Order No.: 74960625.

13.1.2 Bluetooth adapter PCO 300



Including BCSoft CD-ROM,
Order No.: 74960617.

For further information, see page 35 (BCSoft).

13.2 OCU



For installation in the control cabinet door in standard grid dimensions. The program step/status or fault messages can be read on the OCU. In Manual mode, the OCU can be used to proceed through the sequence of operating steps.

For details, see from page 100 (OCU).

OCU 500-1, Order No.: 84327030,
OCU 500-2, Order No.: 84327031,
OCU 500-3, Order No.: 84327032,
OCU 500-4, Order No.: 84327033.

13.3 Connection plug set

For wiring the BCU.

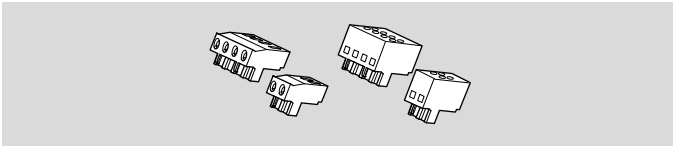

Connection plugs with screw terminals,
Order No.: 74923997.

Connection plugs with spring force terminals, 2 con-
nection options per terminal,
Order No.: 74923999.

13.4 Stickers for labelling

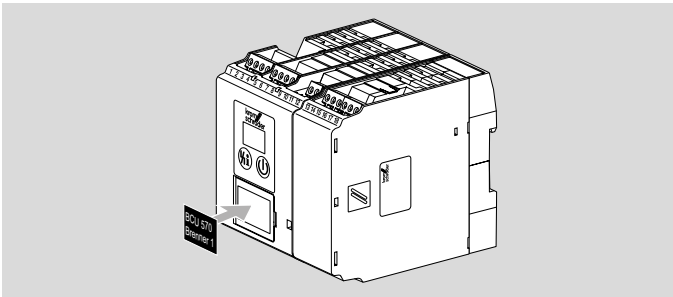

For printing with laser printers, plotters or engraving
machines, 27 × 18 mm or 28 × 17.5 mm.

Colour: silver.

13.5 “Changed parameters” stickers

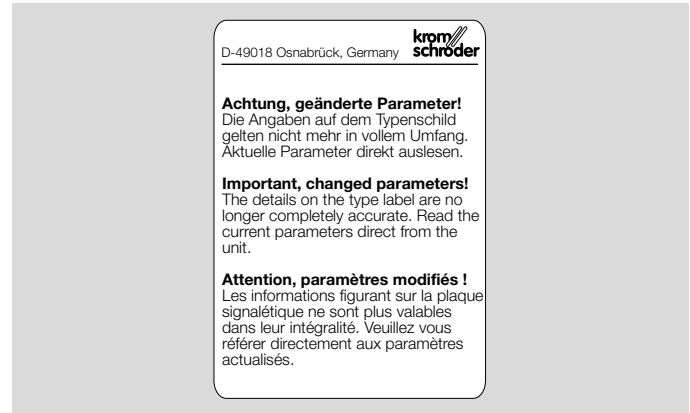

Affix on the BCU following changes to device param-
eters set at the factory.

100 pcs,
Order No.: 74921492.

14 OCU

14.1 Application



The OCU is an external operator-control unit which can be connected to a control unit of the FCU 500/BCU 500 series. The external operator-control unit OCU may be installed in the door of a control cabinet, for example. Thus, the control cabinet does not need to be opened to read out process values, statistics, flame signal intensities or parameter values, to change settings on the OCU or to control or adjust connected butterfly valves in Manual mode.

14.2 Function





The OCU features an illuminated plain-text display. The lighting is switched on when a control key is pressed and switches off automatically after 5 minutes. In case of a fault lock-out or safety shut-down of the control unit, the OCU light starts blinking.

You can choose between the indicating ranges “status display” and “Service mode”.

The status display shows the program step or a fault message which has occurred in text form with the appropriate code.

The Service mode allows you to read out process values, parameter settings, information on the OCU or the statistics. In addition, you can operate connected control units in Manual mode.

There are five control keys for the OCU and the control unit connected to it:

	ON/OFF Use the ON/OFF key to switch the control unit on or off.
	Reset Use the Reset key to reset the control unit to its starting position in the event of a fault (system faults can only be acknowledged using the Reset/Information button on the BCU).
	OK Press the OK key to confirm a selection or query. Starting from the status display, you can use the OK key to change to Service mode.
	Back In Service mode, you can use the Back key to switch from one setting level to the next higher one. By holding down the key for a certain time, you can change directly to the status display.



Navigation UP/DOWN

In Service mode, the navigation keys can be used to select individual functions on one level.
In Manual mode, those keys can be used to open and close an activated valve.

14.2.1 Manual mode

In Manual mode, the control unit works with capacity control (FCU..F1/F2 or BCU..F1/F2) regardless of the status of its inputs. The inputs for start-up signal (terminal 1), controlled air flow (terminal 2) and remote reset (terminal 3) are ignored. The function of the controller enable/emergency stop input (terminal 46) is retained.

The positions for maximum capacity, minimum capacity and ignition capacity of an actuator can be adjusted using the OCU. The OCU supports the process by means of a cyclic, automatic repeat approach to the selected position. The actuator can be moved within the menu to make changes to the cam settings.

After start-up has been completed, the navigation keys can be used, for example, to open or close a valve in program step $\square\square$.

14.3 Electrical connection

The OCU is to be connected to the control unit using the two plugs provided.

Required signal and control line:
 cable length max. 10 m, 4-pin, min. 0.25 mm² (AWG 24),
 max. 0.34 mm² (AWG 22).

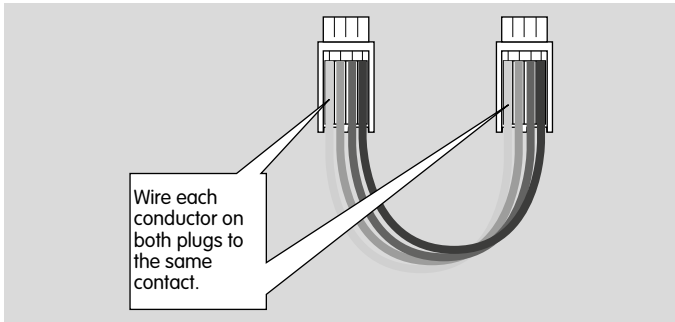
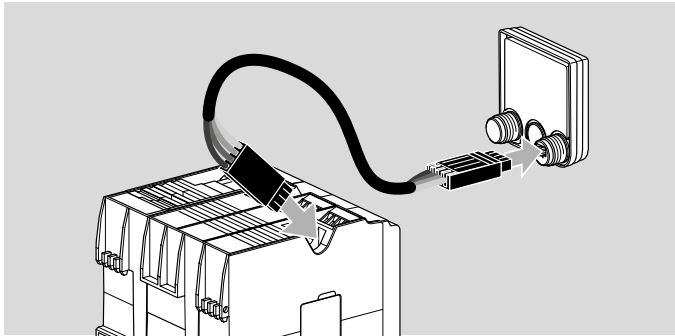

14.4 Installation

The threaded adapters of the OCU are suitable for 22 mm boreholes which are drilled at intervals of 30 mm.

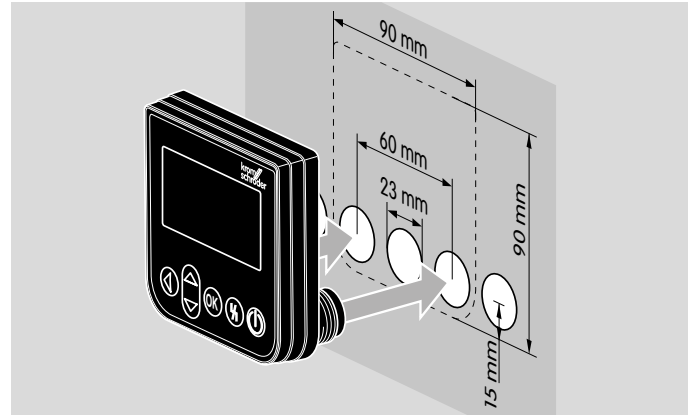

14.5 Selection

The OCU can be supplied with various language kits.

Type	Languages	Order No.
OCU 500-1	German, English, French, Dutch, Spanish, Italian	84327030
OCU 500-2	English, Danish, Swedish, Norwegian, Turkish, Portuguese	84327031
OCU 500-3	English, US English, Spanish, Brazilian Portuguese, French	84327032
OCU 500-4	English, Russian, Polish, Croatian, Romanian, Czech	84327033

14.6 Technical data

Ambient temperature: -20 to +60°C.

Relative humidity:

30% to 95% (no condensation permitted).

Enclosure: IP 65 when fitted (control cabinet door).

Dimensions of the operator-control unit:

90 x 90 x 18 mm (W x H x D).

Electrical connection

Connection data:

wire cross-section (flexible) min. 0.25 mm²,

wire cross-section (flexible) max. 0.34 mm²,

wire cross-section AWG min. 24,

wire cross-section AWG max. 22,

AWG to UL/CUL min. 24,

AWG to UL/CUL max. 22.

Cable length: inside control cabinet max. 10 m.

15 BCM

15.1 Application



The bus module BCM 500 is used as a communication interface for devices of the BCU/FCU 500 product family. Networking via Profinet, for example, enables the FCU or BCU to be controlled and monitored by an automation system (e.g. PLC).

15.2 Function

The bus system transfers the control signals for starting, resetting and for controlling the air valve to purge the furnace or kiln or for cooling in start-up position and heating during operation from the automation system (PLC) to the BCM. In the opposite direction, it sends operating status, the level of the flame signal and the current program step.

15.3 Electrical connection

Use only cable and plug components which comply with the appropriate Profinet specifications.

Use shielded RJ45 plugs.

Cable length between 2 Profinet stations: max. 100 m.

Profinet installation guidelines, see www.profibus.com.

15.4 Installation

Installation position: vertically upright, horizontal or tilted to the left or right.

The BCM mounting is designed for horizontally aligned 35 × 7.5 mm DIN rails.

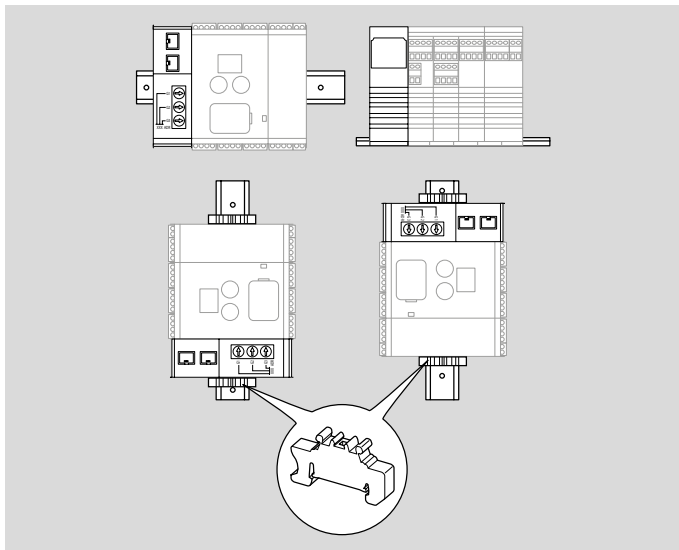

If the DIN rail is aligned vertically, end clamps are required (e.g. Clipfix 35 by Phoenix Contact) to prevent the control unit from slipping.

Install in a clean environment (e.g. a control cabinet) with an enclosure \geq IP 54, whereby no condensation is permitted.

15.5 Selection

Code	Description
BCM	Bus module
500	Series 500
S0	Standard communication
B2	Profinet
/3	Two RJ45 sockets
-3	Three-point step control via bus

Order No.: 74960663

15.6 Technical data

Electrical data

Power consumption: 1.2 VA.

Power loss: 0.7 W.

Mechanical data

Dimensions (W × H × D):
32.5 × 115 × 100 mm.

Weight: 0.3 kg.

Environment

Ambient temperature:
-20 to +60°C (-4 to +140°F).

Storage temperature:
-20 to +60°C (-4 to +140°F).

Climate: no condensation permitted.

Enclosure: IP 20 pursuant to IEC 529.

Installation location: min. IP 54 (for installation in a control cabinet).

16 Technical data

16.1 Electrical data

Mains voltage

BCU 570Q: 120 V AC, -15/+10%, 50/60 Hz, $\pm 5\%$,
BCU 570W: 230 V AC, -15/+10%, 50/60 Hz, $\pm 5\%$.

Type of network

For grounded or ungrounded mains. The national standards and safety requirements must be satisfied. If the BCU is operated in ungrounded/IT systems, an insulation monitoring device must be provided to isolate it from the mains supply on all poles in the event of a fault. The cabling of the safety circuits (e.g. pressure switches, gas valves) outside enclosed installation spaces must be protected from mechanical damage and stress (e.g. vibration or bending) as well as short-circuits, short-circuits to ground and cross-circuits.

Power consumption

At 230 V AC approx. 6 W/11 VA,
at 120 V AC approx. 3 W/5.5 VA.

Signal inputs

Rated value	120 V AC	230 V AC
Signal "1"	80 – 132 V	160 – 253 V
Signal "0"	0 – 20 V	0 – 40 V
Current at "1"	max. 5 mA*	
Power loss	0.08 W/0.2 VA	0.15 W/0.4 VA

* The signal inputs are activated by pulses.
The stated current corresponds to the peak value.

Signal outputs (contact rating)

- Valve outputs V1, V2, V3 and V4 (terminals 13, 14, 15 and 57):
max. 1 A each, $\cos \varphi \geq 1$.
- Actuator outputs (terminals 53, 54 and 55):
max. 1 A each, $\cos \varphi \geq 1$.
- Ignition transformer (terminal 9): max. 2 A,
2.5 A pilot duty (to UL approval).
- Total current for the simultaneous activation of the valve outputs (terminals 13, 14, 15 and 57), the actuator (terminals 53 – 56) and the ignition transformer:
max. 2.5 A.
- Fan (terminal 58):
max. 3 A (start-up current: 6 A < 1 s),
3FLA, 18LRA (to UL approval).
- Signalling contact for operating and fault signals:
max. 1 A (external fuse required).

Number of operating cycles

The fail-safe outputs (valve outputs V1, V2, V3 and V4) are monitored for correct functioning and are thus not subject to a max. number of operating cycles. Actuator (terminals 53, 54 and 55): max. 250,000, signalling contact for operating signals: max. 250,000, signalling contact for fault signals: max. 10,000, On/Off button: max. 10,000, Reset/Information button: max. 10,000.

Device fuses

Fuses, replaceable,

F1: T 3.15A H, F2: T 5A H, pursuant to IEC 60127-2/5.

Flame control

With UV sensor or ionization sensor,
for continuous operation (intermittent operation with UVS).

Flame signal current:

ionization control: 2 – 25 μ A,

UV control: 5 – 25 μ A.

Signal line for flame signal current: max. 100 m (164 ft).

16.2 Mechanical data

Weight: 0.7 kg.

Connections

- Screw terminals:
 - nominal cross-section 0.2 mm²,
 - wire cross-section (rigid) min. 0.2 mm²,
 - wire cross-section (rigid) max. 2.5 mm²,
 - wire cross-section AWG min. 24,
 - wire cross-section AWG max. 12.
- Spring force terminals:
 - nominal cross-section 2 x 1.5 mm²,
 - wire cross-section min. 0.2 mm²,
 - wire cross-section AWG min. 24,
 - wire cross-section AWG max. 16,
 - wire cross-section max. 1.5 mm²,
 - rated current 10 A (8 A UL),
 - to be observed in case of daisy chain.

16.3 Environment

Ambient temperature:

-20 to +60°C (-4 to +140°F),

no condensation permitted.

Enclosure: IP 20 pursuant to IEC 529.

Installation location: min. IP 54 (for installation in a control cabinet).

16.4 Dimensions

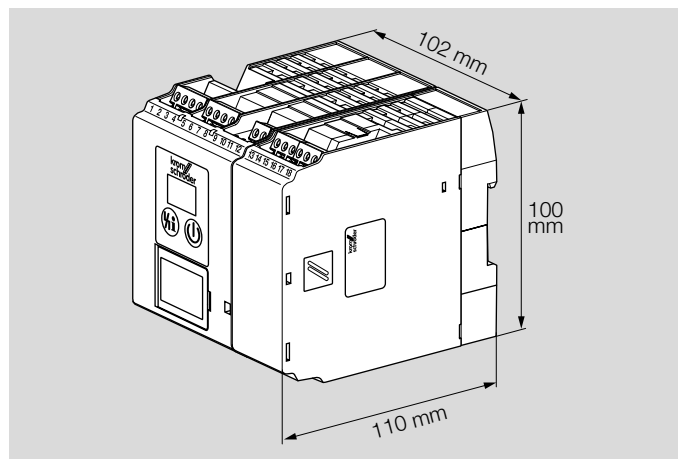

16.5 Safety-specific characteristic values

Suitable for Safety Integrity Level	Up to SIL 3
Diagnostic coverage DC	98.8%
Type of subsystem	Type B to EN 61508-2:2010
Operating mode	High demand mode pursuant to EN 61508-4:2010
Mean probability of dangerous failure PFH _D	14.6 x 10 ⁻⁹ 1/h on BCU 570..F1 13.2 x 10 ⁻⁹ 1/h on BCU 570..F2
Mean time to dangerous failure MTTF _d	MTTF _d = 1/PFH _D
Safe failure fraction SFF	99.8%

Mean probability of dangerous failure PFH_D of individual safety functions

Valve proving system	7.2 x 10 ⁻⁹ 1/h
Emergency stop	7.2 x 10 ⁻⁹ 1/h
Emergency stop with optional input	7.1 x 10 ⁻⁹ 1/h
Low air pressure protection	7.2 x 10 ⁻⁹ 1/h
Low air pressure protection with optional input	7.1 x 10 ⁻⁹ 1/h
Low gas pressure protection	7.2 x 10 ⁻⁹ 1/h
Low gas pressure protection with optional input	7.1 x 10 ⁻⁹ 1/h
High gas pressure protection	7.2 x 10 ⁻⁹ 1/h
High gas pressure protection with optional. input	7.1 x 10 ⁻⁹ 1/h
Capacity control	7.2 x 10 ⁻⁹ 1/h
Air flow monitoring with optional input	7.1 x 10 ⁻⁹ 1/h
Flame control	8.7 x 10 ⁻⁹ 1/h
Approaching position for ignition capacity with IC 20	8.0 x 10 ⁻⁹ 1/h
Approaching position for ignition capacity with RBW	7.9 x 10 ⁻⁹ 1/h

SIL 3 is only achieved in conjunction with actuators IC 20 or RBW if a separate gas valve is used to limit the pilot gas rate, see page 56 (Burner application), parameter 78 = 1 or 3.

Relationship between the Performance Level (PL) and the Safety Integrity Level (SIL)

PL	SIL
a	-
b	1
c	1
d	2
e	3

Pursuant to EN ISO 13849-1:2006, Table 4, the BCU can be used up to PL e.

Max. service life under operating conditions:
20 years after date of production.

For a glossary of terms, see page 112 (Glossary).

For further information on SIL/PL, see www.k-sil.de.

16.6 Converting units

See www.adlatus.org

17 Maintenance

The fail-safe outputs (valve outputs V1, V2, V3 and V4) of the power module are monitored for correct functioning. In the event of a fault, the system is set to a safe status using a second shut-down path (isolation of the valve outputs from the mains). In the event of a defect (e.g. fault 36), the power module must be replaced.





















See www.partdetective.de





for a replacement/order option for the power module.

The device and user statistics can be displayed using the operator-control unit OCU or engineering tool BCSoft for further diagnostics and troubleshooting.

The user statistics can be reset using engineering tool BCSoft.

18 Legend

	Ready for operation
	Safety interlocks (limits)
	Control element position check
LDS	Safety limits (limits during start-up)
	Gas valve
	Air valve
	Air/gas ratio control valve
	Gas pilot (burner 1)
	Main burner (burner 2)
	Purge
	External air valve control
	Operating signal
	Fault signal
	Start-up signal (BCU)
	Emergency stop
	Pressure switch for tightness control (TC)
	Pressure switch for maximum pressure
	Pressure switch for minimum pressure
	Differential pressure switch
	Input signal depending on parameter xx
	Actuator with butterfly valve
TC	Tightness control
$p_u/2$	Half of the inlet pressure

p_u	Inlet pressure
p_d	Outlet pressure
V_{p1}	Test volume
	Valve with proof of closure switch
	Fan
	Three-point step switch
	Input/Output, safety circuit
I_N	Current consumption of sensor/contactactor
t_L	Tightness control opening time
t_M	Measurement time during tightness test
t_p	Tightness control test period (= $2 \times t_L + 2 \times t_M$)
t_{FS}	Flame proving period
t_{PN}	Post-purge time
t_{GV}	Fan run-up time
t_E	Switch-on delay
t_{SA}	Safety time on start-up
t_{VZ}	Pre-ignition time
t_{PV}	Pre-purge time
t_{RF}	Controller enable signal delay time
t_{MP}	Minimum pause time

19 Glossary

19.1 Waiting time t_W

In standby, the waiting time t_W starts to elapse in the background. During the waiting time (display HD), a self-test is conducted to detect errors in internal and external circuit components. If no malfunction is detected, the BCU can start the burner.

19.2 Ignition time t_Z

If no malfunction is detected during the waiting time t_W , the ignition time t_Z then starts to elapse. Voltage is supplied to gas valves V1 and V2 as well as to the ignition transformer. The burner is ignited. The duration of the ignition time is either 1, 2, 3 or 6 s (depending on safety time t_{SA1} selected).

19.3 Safety interlocks

The limiters in the safety interlock (linking of all the relevant safety control and switching equipment for the use of the application, e.g. safety temperature limiter, minimum/maximum gas pressure) must isolate input  from the voltage supply.

19.4 Safety time on start-up t_{SA1}

This refers to the period of time between switching on and switching off of the gas valve, when no flame signal is detected. The safety time on start-up t_{SA1} (2, 3, 5 or 10 s) is the minimum operating time of the burner and burner control unit.

19.5 Safety time during operation t_{SB}

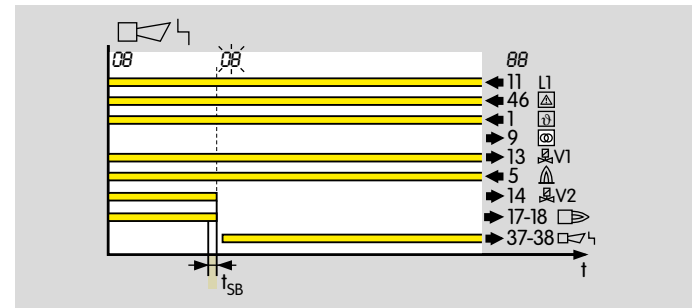

If the flame fails during operation, the output for valve V2 is disconnected within the safety time t_{SB} .

The default safety time during operation t_{SB} in accordance with EN 298 is 1 second. In accordance with EN 746-2, the safety time of the installation during operation (including closing time of the valves) must not exceed 3 seconds. Note the requirements of the standards!

19.6 Safety shut-down

The burner control unit performs a safety shut-down immediately after receiving a signal from a safety device or after a fault is detected (e.g. flame or air pressure failure). The safety shut-down prevents operation of the burner by closing the fuel shut-off valves and deactivating the ignition device.

For this, the BCU disconnects the gas valves and the ignition transformer from the electrical power supply. The operation signalling contact and the controller enable signal are deactivated. The fault signalling contact remains open. The display blinks and displays the current program step, see page 46 (Fault signalling).

After a safety shut-down, the BCU can restart automatically.

19.7 Fault lock-out

A fault lock-out is a safety shut-down with subsequent lock-out. The system can only be restarted following manual reset. The protective system cannot be reset by mains failure.

In the event of a fault lock-out of the BCU, the fault signalling contact closes, the display blinks and shows the current program step, see page 46 (Fault signalling). The gas valves are disconnected from the electrical power supply. The fault signalling contact opens if the mains voltage fails.

In order to restart, the BCU can only be reset manually using the button on the front panel, the OCU or the remote reset input (terminal 3).

19.8 Warning signal

The BCU reacts to operating faults, e.g. in the case of permanent remote resets, with a warning signal. The display blinks and shows the corresponding warning message. The warning signal ends once the cause has been eliminated.

The program sequence continues. No safety shut-down or fault lock-out occurs.

19.9 Timeout

For some process faults, a timeout phase elapses before the BCU reacts to the fault. The phase starts as soon as the BCU detects the process fault and ends after 0 to 255 s. A safety shut-down or fault lock-out is then performed. If the process fault ends during the timeout phase, the process continues as before.

19.10 Lifting

After positioning the actuator IC 20, the BCU checks by means of brief lifting whether its feedback input (terminal 52) has been activated by the correct output signal from the actuator. The signal of the relevant control output (ignition, OPEN, CLOSE) is switched off briefly for this purpose. While the signal is switched off, the BCU may not detect a signal at the feedback input.

19.11 Air valve

The air valve can be used

- for cooling,
- for purging,
- to control the burner capacity in ON/OFF mode and in High/Low mode when using a pneumatic air/gas ratio control system.

19.12 Diagnostic coverage DC

Measure of the effectiveness of diagnostics, which may be determined as the ratio between the failure rate of detected dangerous failures and the failure rate of total dangerous failures

NOTE: Diagnostic coverage can exist for the whole or parts of a safety-related system. For example, diagnostic coverage could exist for sensors and/or automation system and/or control elements. Unit: %.

from EN ISO 13849-1:2008

19.13 Mode of operation

IEC 61508 describes two modes of operation for safety functions. These are low demand mode and high demand or continuous mode.

In low demand mode, the frequency of demands for operation made on a safety-related system is not greater than one per year and is not greater than twice the proof-test frequency. In high demand mode or continuous mode, the frequency of demands for operation made on a safety-related system is greater than one per year or greater than twice the proof-test frequency.

See also IEC 61508-4

19.14 Safe failure fraction SFF

Fraction of safe failures related to all failures, which are assumed to appear

from EN 13611/A2:2011

19.15 Probability of dangerous failure PFH_D

Value describing the likelihood of dangerous failure per hour of a component for high demand mode or continuous mode. Unit: 1/h.

from EN 13611/A2:2011

19.16 Mean time to dangerous failure MTTF_d

Expectation of the mean time to dangerous failure

from EN ISO 13849-1:2008

Feedback

Finally, we are offering you the opportunity to assess this “Technical Information (TI)” and to give us your opinion, so that we can improve our documents further and suit them to your needs.

Clarity

- Found information quickly
- Searched for a long time
- Didn't find information
- What is missing?
- No answer

Comprehension

- Coherent
- Too complicated
- No answer

Scope

- Too little
- Sufficient
- Too wide
- No answer



Use

- To get to know the product
- To choose a product
- Planning
- To look for information

Navigation

- I can find my way around
- I got “lost”
- No answer

My scope of functions

- Technical department
- Sales
- No answer

Remarks

Contact

Elster GmbH
Postfach 2809 · 49018 Osnabrück
Strothweg 1 · 49504 Lotte (Büren)
Germany

Tel. +49 541 1214-0
Fax +49 541 1214-370
hts.lotte@honeywell.com
www.kromschroeder.com

The current addresses of our international agents
are available on the Internet:
www.kromschroeder.de/Weltweit.20.0.html?&L=1

We reserve the right to make technical
modifications in the interests of progress.
Copyright © 2018 Elster GmbH
All rights reserved.

